

BOSS

INSTRUMENTS LTD

VASCULAR CLAMPS



Precision Surgical Ltd., Globe Centre, Penistone Road, Sheffield S6 3AE
t: +44 (0)114 270 1000 f: +44 (0)870 838 1374 e: info@precisionsurgical.co.uk
www.precisionsurgical.co.uk
Company Reg. No. 5899466, VAT Reg. 894 8049 70

Cooley Neonatal Vascular Clamp

65-6100*
straight
cooley jaw
5" (12.5cm)



Cooley Neonatal Vascular Clamp

65-6102*
straight
angled shanks
cooley jaw
5" (12.5cm)



Cooley Neonatal Vascular Clamp

65-6103*
angled
curved shanks
cooley jaw
5" (12.5cm)



Cooley Neonatal Vascular Clamp

65-6104*
cooley spoon jaw
5" (12.5cm)



Neonatal Vascular Clamps
cooley jaw

65-6105*
anastomosis clamp
5" (12.5cm)



Cooley Neonatal Vascular Clamp

65-6106*
carotid clamp
5" (12.5cm)



Cleveland Clinic Renal Clamps
9³/₈" (24.5cm)
debakey jaw

65-6112*
left
large

65-6114
right
large



Kitzmilller Clamps
4³/₈" (11cm)
cooley jaw

65-6116*
left angled jaw

65-6118
right angled jaw

65-6116T
titanium
left angled jaw

65-6118T
titanium
right angled jaw



Cooley Pediatric Clamps

65-6120
straight shanks
straight jaw
5 1/4" (13.3cm)

65-6121
straight shanks
angled jaw
5 1/4" (13.3cm)

65-6123*
straight shanks
spoon jaw
5 1/4" (13.3cm)

65-6124
angled shanks
straight jaw
5 1/2" (14cm)



Cooley Pediatric Clamps
5 1/4" (13.3cm)

65-6122*
12mm (1/2") jaw

65-6125
20mm (3/4") jaw

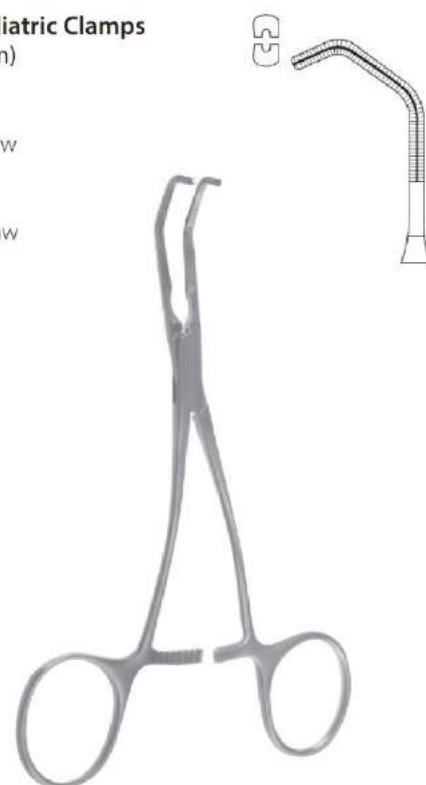

Satinsky Pediatric Clamps
cooley jaw

65-6127*
5 1/2" (14cm)



Cooley Occlusion Clamps
5 1/2" (14cm)

65-6130*
right angled jaw
17mm jaw

65-6131
right angled jaw
25mm jaw

65-6132
right angled jaw
35mm jaw



Cooley Anastomosis Clamps

65-6135*
calibrated jaws
7 1/8" (18.1cm)

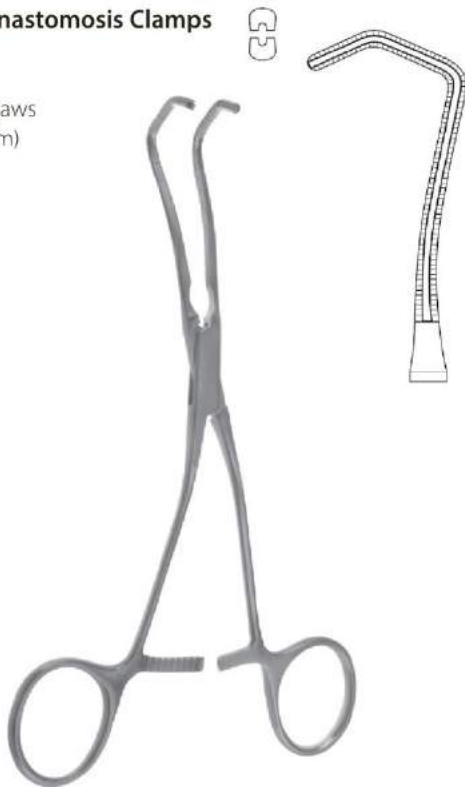

Cooley Patent Ductus Clamps
6 1/4" (16cm)

65-6140
straight shaft

65-6141*
angled shaft



Cooley Coarctation Clamps
6 3/4" (17.1cm)

65-6150*
straight
straight shaft

65-6153
straight
angled shaft

65-6151
curved
straight shaft

65-6152
spoon jaw
straight shaft

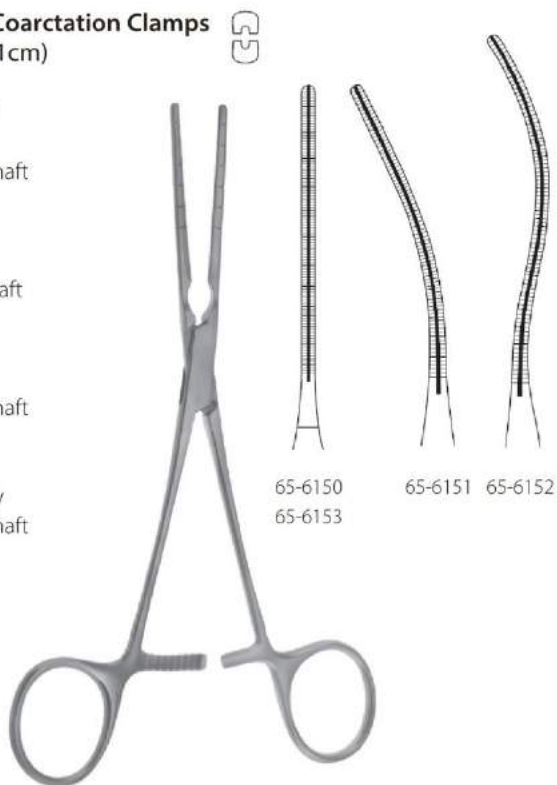

Example Carotid Clamps

65-6165*
curved handle
long thin jaw
6" (15cm)



Thompson Carotid Clamps

65-6180*
curved shanks
6" (15cm)



Kartchner Carotid Clamp

65-6185*
curved shanks
6" (15cm)



Calman Carotid Clamps

65-6160*
angled handle
long thin jaw
4 1/4" (10.8cm)



Cooley Multi-Purpose Clamps 

65-6192
angled 30°
6½" (16.5cm)

65-6191*
angled 60°
6" (15cm)

65-6190
angled 90°
5½" (14cm)

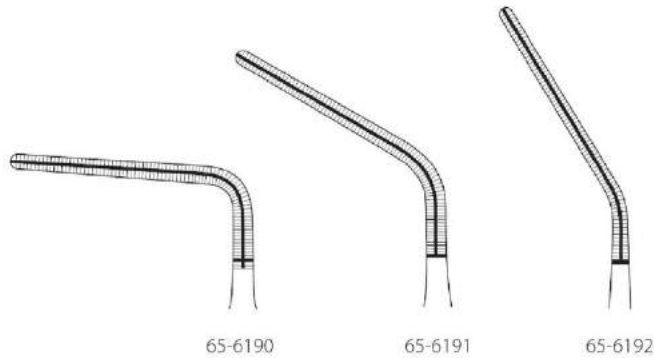
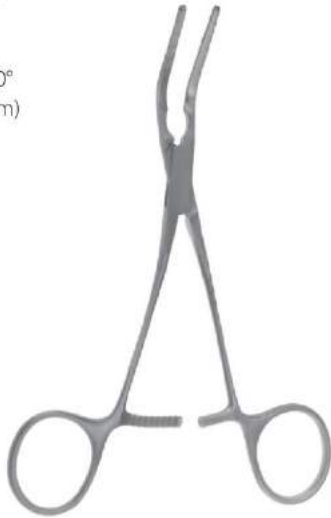

65-6190

65-6191

65-6192

Cooley Curved Clamp 

65-6200*
fully curved jaw
6½" (16.5cm)

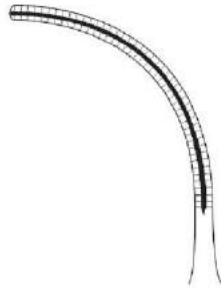

Cooley Vascular Clamps 

65-6210
small jaw
angled 90°

65-6211*
large jaw
angled 90°

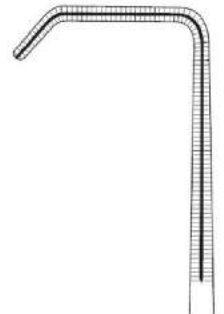

65-6210

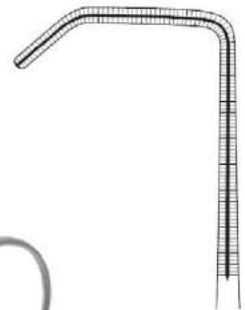

65-6211

Cooley Vascular Clamps 

65-6212
small jaw
angled 60°

65-6213*
large jaw
angled 60°

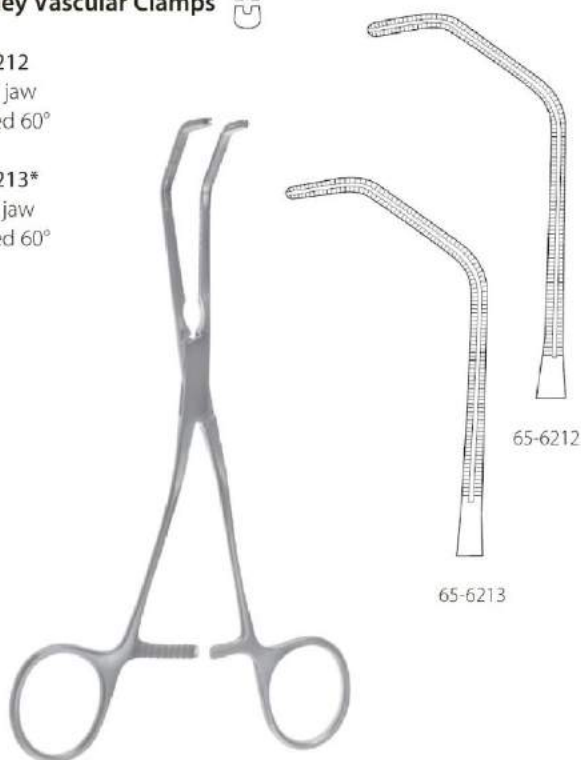

Cooley Acutely Curved Clamp 

65-6220*
small ligature carrier
6 3/4" (17.1cm) overall length





Cooley Cardio Clamps 

6 1/2" (16.5cm)

65-6221*
acutely curved clamp
medium jaw

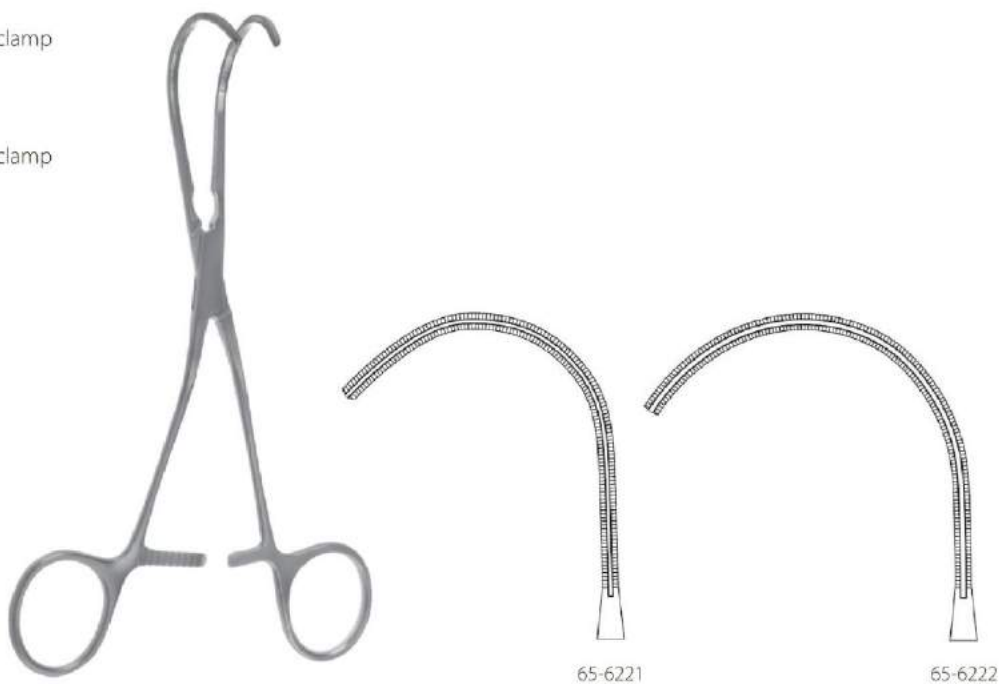
65-6222
acutely curved clamp
large jaw



Cooley Multi-Purpose Clamps 

65-6224*
calibrated jaw
1 1/4 x 5/8" (3.2 x 1.6cm)

65-6225
calibrated jaw
1 1/2 x 3/4" (3.8 x 1.9cm)

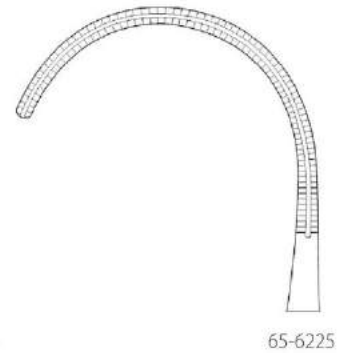
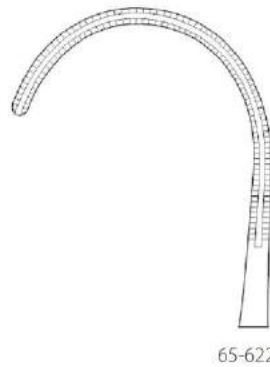

DeBakey Multi-Purpose Clamps 

65-6230*
angled 30°
6 1/2" (16.5cm)

65-6231
angled 60°
6" (15cm)

65-6232
angled 90°
5 1/2" (14cm)

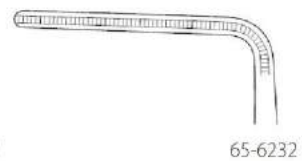

Reynolds Vascular Clamps
debakey teeth



65-6240*
small
angled 50°
overall length:
7" (18cm)

65-6241
large
angled 50°
overall length:
7" (18cm)

65-6242
small
angled 85°
overall length:
6½" (16.5cm)

65-6243
large
angled 85°
overall length:
6½" (16.5cm)



65-6240



65-6241

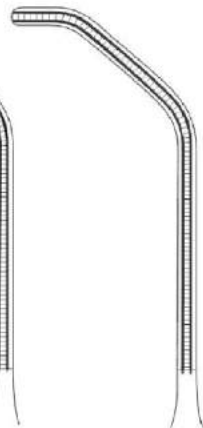

65-6242



65-6243

Subramanian Mini Aorta Clamps
debakey teeth



65-6250*
5½" (14cm)

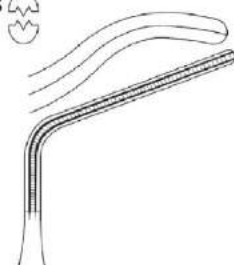

Cooley Cardio Clamps



10¾" (27.3cm)

65-6253*
2¾" (7cm) jaw

65-6252
2¾" (7.3cm) jaw



Beck Vascular Clamps
cooley jaw



65-6255
small
cooley jaw
heavy curve

65-6256*
large
cooley jaw
medium curve



65-6255

65-6256

Beck Miniature Aorta Clamps
debakey teeth



65-6260*
straight shanks
6¾" (17.1cm)



Beck Aorta Clamps
debakey teeth



65-6257
acutely angled jaw
overall length:
8¾" (22.2cm)

65-6258*
acutely angled
6mm jaw
8" (20cm)

65-6259
acutely angled
6.7cm jaw
8¼" (21cm)

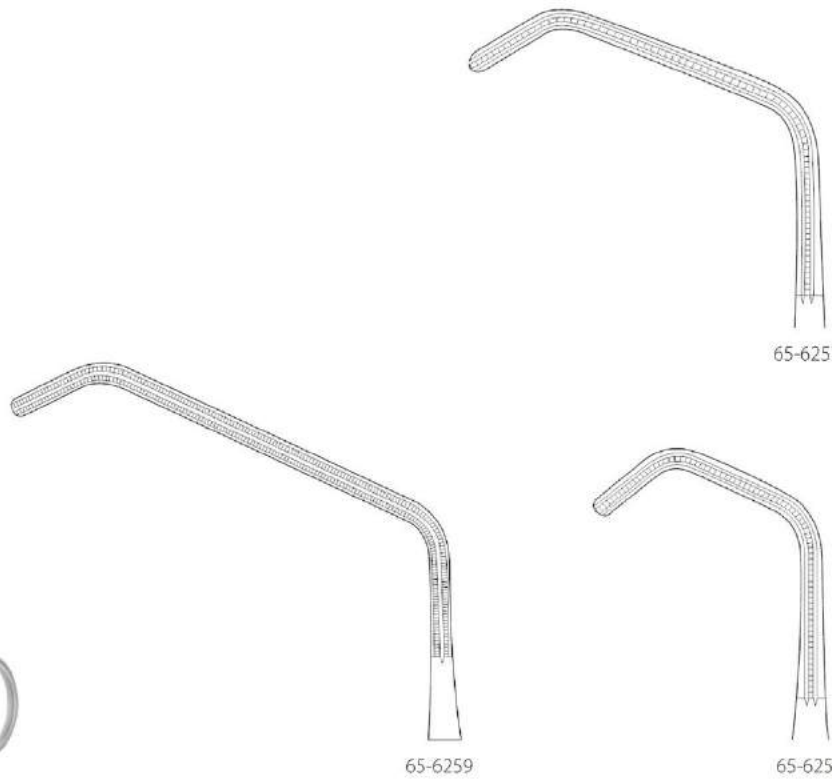

65-6257

65-6259

65-6258

Bailey Aorta Clamps
debakey teeth



65-6262*
angled shanks
3 x .8cm jaw
8" (20cm)

65-6263
angled shanks
4.5 x 1.1cm jaw
8½" (21.5cm)

65-6264
angled shanks
5.5 x 1.1cm jaw
8¾" (22cm)



65-6262

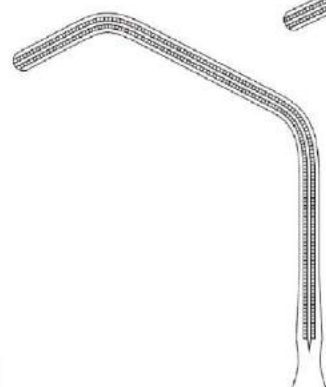
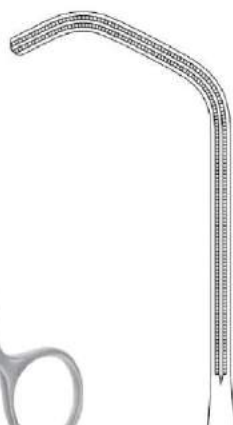

65-6263

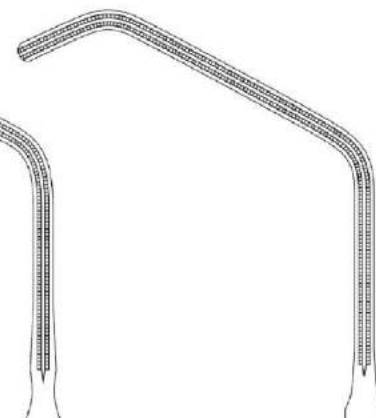

65-6264

Castaneda Clamps
5" (12.5cm)
multi-purpose

65-6265
neonatal vascular
straight jaw
curved shanks

65-6266
30° angled jaw
curved shanks

65-6267
50° angled jaw
curved shanks

65-6268*
90° angled jaw
curved shanks



65-6265

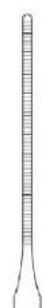

65-6266

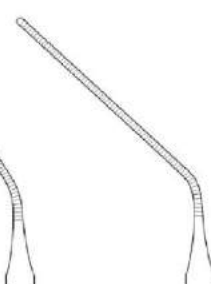

65-6267



65-6268

Castaneda Anastomosis Clamps
6" (15cm)

65-6269
small
curved shanks

65-6270*
medium
curved shanks

65-6271
large
curved shanks

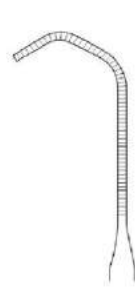

65-6269



65-6270

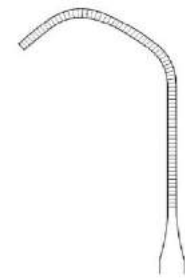

65-6271

Castaneda Spoon Jaw Clamps

65-6272*
curved shanks
spoon jaw
4 3/4" (12cm)

65-6273
straight shanks
spoon jaw
5" (12.5cm)

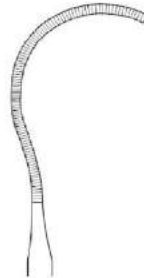

DeBakey Pediatric Patent Ductus Clamps

65-6280
straight shanks
6 1/4" (16cm)

65-6281*
angled shanks
6 3/4" (17.1cm)



DeBakey Pediatric Patent Ductus Spoon Jaw Clamp

65-6282*
5¾" (14.6cm)

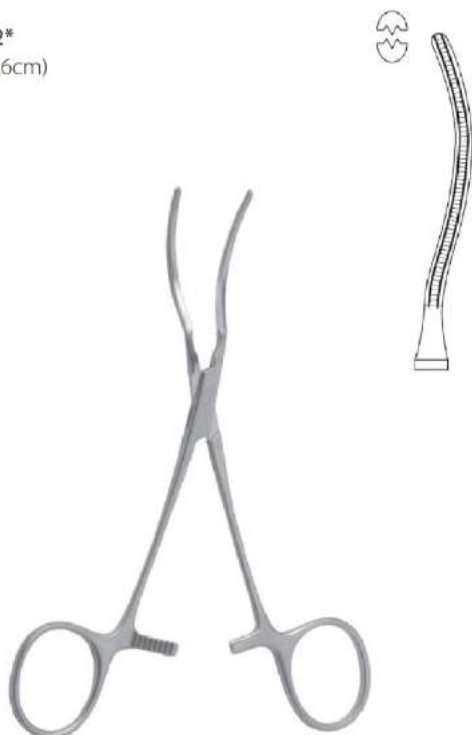

DeBakey Acutely Curved Clamp

65-6290*
6¾" (17.1cm)



Selman-Cooley Peripheral Blood Vessel Forceps

65-6300
small
straight
5" (12.5cm)



65-6301*
large
straight
5½" (14cm)

Selman-Cooley Peripheral Blood Vessel Forceps

65-6302*
small
angled
5" (12.5cm)



65-6303
large
angled
5½" (14cm)

Selman-Cooley Peripheral Blood Vessel Forceps



65-6304*
small
full curved jaw
5" (12.5cm)

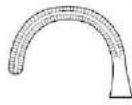

Cooley Anastomosis Clamp



65-6356*
standard
6 1/2" (16.5cm)

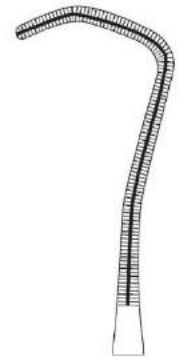

Cooley-Derra Anastomosis Clamps



6 1/2" (16.5cm)

65-6360
small jaw

65-6361*
medium jaw

65-6362
large jaw



65-6360



65-6361

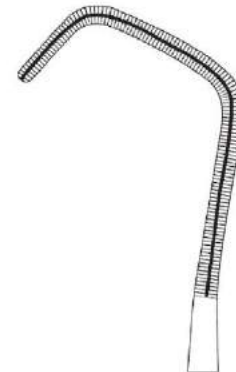

65-6362

Derra Vena Cava Clamps

65-6364
small
longitudinal serrations

65-6365
medium
longitudinal serrations
7 1/2" (19cm)

65-6366*
large
longitudinal serrations



DeBakey-Derra Anastomosis Clamps
6 1/2" (16.5cm)

65-6370*
small jaw

65-6371
medium jaw

65-6372
large jaw

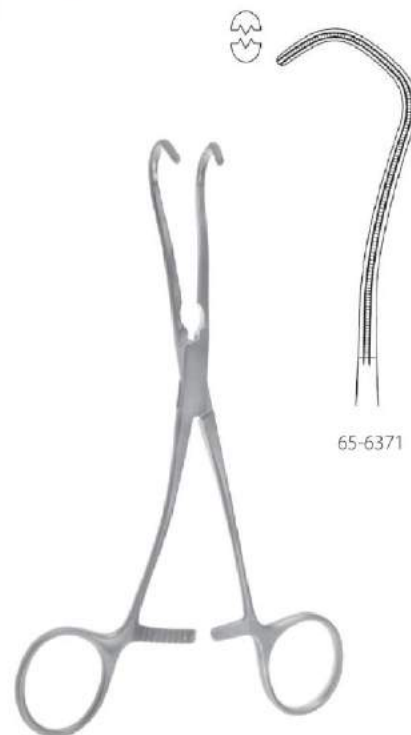

65-6371

Cooley Anastomosis Clamps
6 1/2" (16.5cm)

65-6380*
calibrated jaw

65-6381
angled shanks
7.3mm jaw

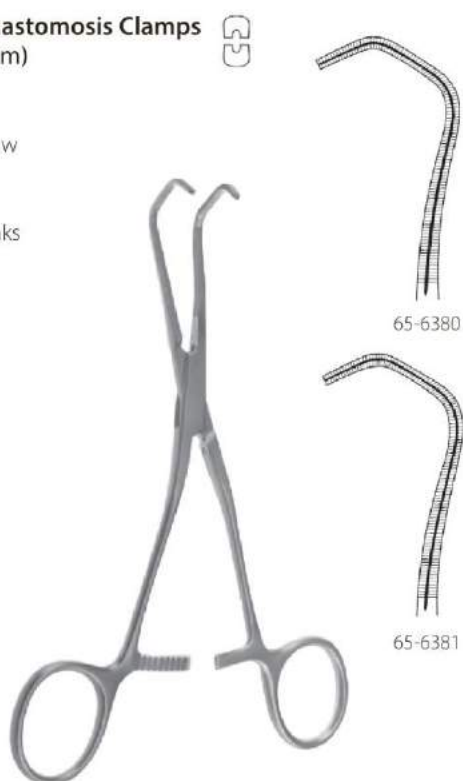

65-6380

65-6381

Cooley Anastomosis Clamp

65-6385*
angled 30°
side angled
6 3/4" (17.5cm)

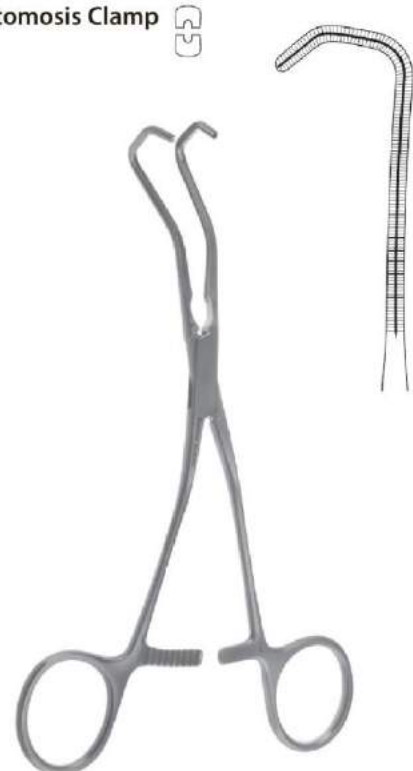

Glover Patent Ductus Clamps
8" (20cm)
debakey teeth

65-6390*
straight shanks
straight jaw

65-6391
angled shanks
straight jaw

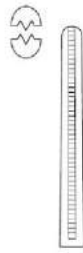

Glover Coarctation Clamps
8 3/4" (22.2cm)
debakey teeth

65-6395
straight shanks
straight jaw 2 1/8" (5.5cm)

65-6396*
angled shanks
straight jaw 2 1/8" (5.5cm)

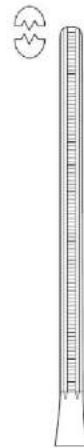

Glover Coarctation Clamps
10 1/2" (26.7cm)
extra long, debakey teeth

65-6399
straight jaw
straight shanks

65-6400*
angled jaw
angled shanks

65-6410
straight shanks

65-6411
angled shanks

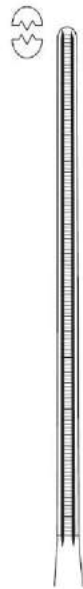

65-6399
65-6400

DeBakey Patent Ductus Clamps
8" (20cm)

65-6401
straight shanks

65-6402*
angled shanks

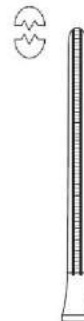

DeBakey Renal Artery Clamp

65-6403*
curved shanks
angled jaw
10" (25.4cm)



DeBakey Coarctation Clamps
9" (23cm)

65-6405*
straight shanks
straight jaw
2 1/8" (5.5cm)

65-6406
angled shanks
straight jaw
2 1/8" (5.5cm)



DeBakey Multi-Purpose Peripheral Clamp

65-6420*
curved shanks
angled jaws
7" (18cm)



DeBakey S-Shaped Peripheral Vascular Clamp

65-6425*
curved shanks
curved jaws
8" (20cm)

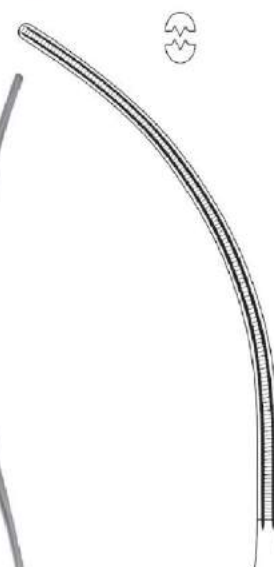

Aortic Exclusion Clamps 
debakey teeth

65-6427*
s-shaped
curved jaw
7¼" (18.5cm)



Leland Jones Peripheral Vascular Clamps 
7½" (19cm)
debakey teeth

65-6435
straight

65-6436
angled 30°

65-6437*
angled 15°

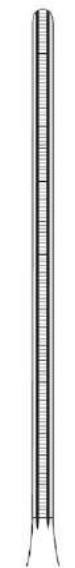

65-6435

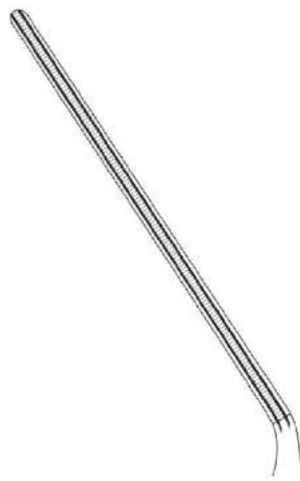

65-6436



65-6437

Cooley Peripheral Vascular Clamps



65-6439
straight
6¾" (17.1cm)

65-6440*
angled jaw 45°
7" (18cm)

65-6441
angled jaw 55°
6½" (16.5cm)

65-6442
angled jaw 55°
6¾" (17.1cm)

65-6443
angled jaw 55°
7" (18cm)

65-6444
7½" (19cm)



65-6439

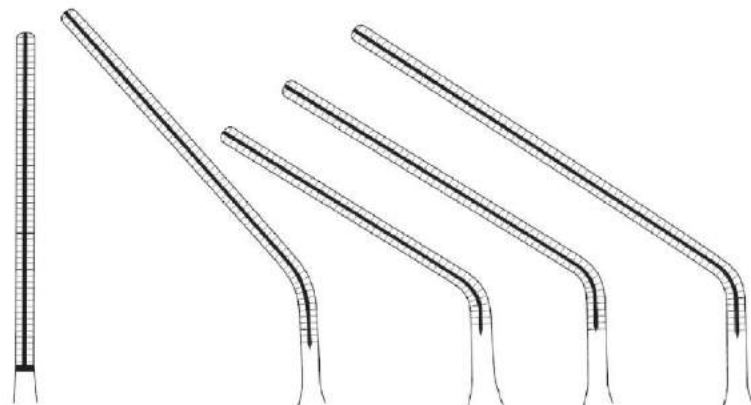

65-6440

65-6441

65-6442

65-6443

Cooley Iliac Clamps



65-6445
2⅞" (5.5cm) jaw
8½" (21.5cm)

65-6446*
2⅞" (6cm) jaw
10" (25.4cm)

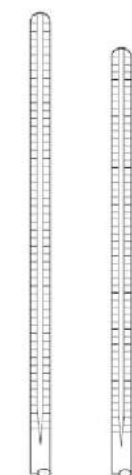

65-6446 65-6445

Cooley Cardio Clamp



65-6447*
curved jaw
10¾" (27.3cm)

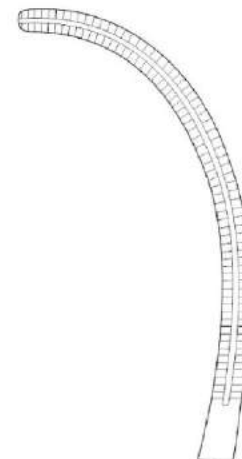

Cooley Auricular Appendage Forceps

65-6448*
9½" (24cm)



DeBakey Peripheral Vascular Clamp

65-6450*
curved jaw
6" (15cm)



Cooley Curved Peripheral Vascular Clamp

65-6453*
6½" (16.5 cm)



DeBakey Acutely Curved Clamp 

65-6456*
large jaw
10" (25.4cm)

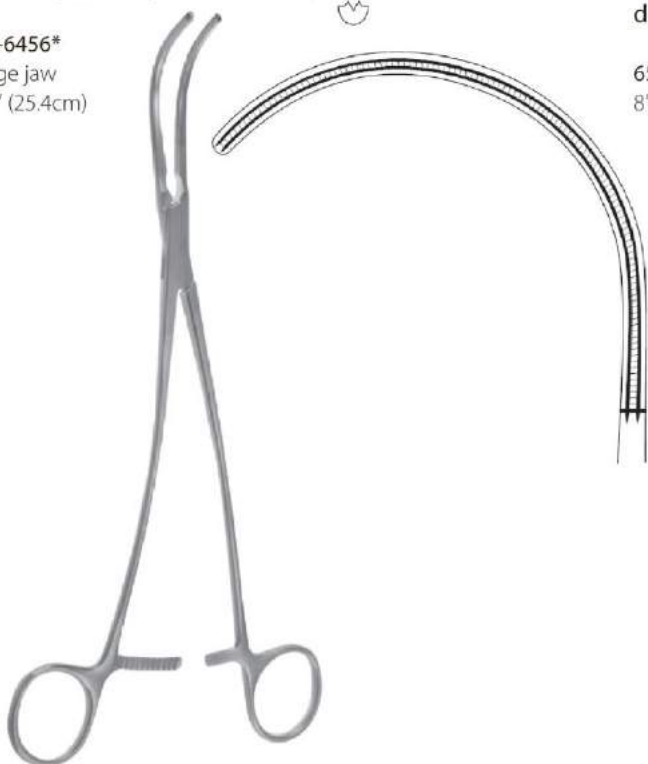

Henly Subclavian Artery Clamps 
debakey teeth

65-6460*
8" (20cm)

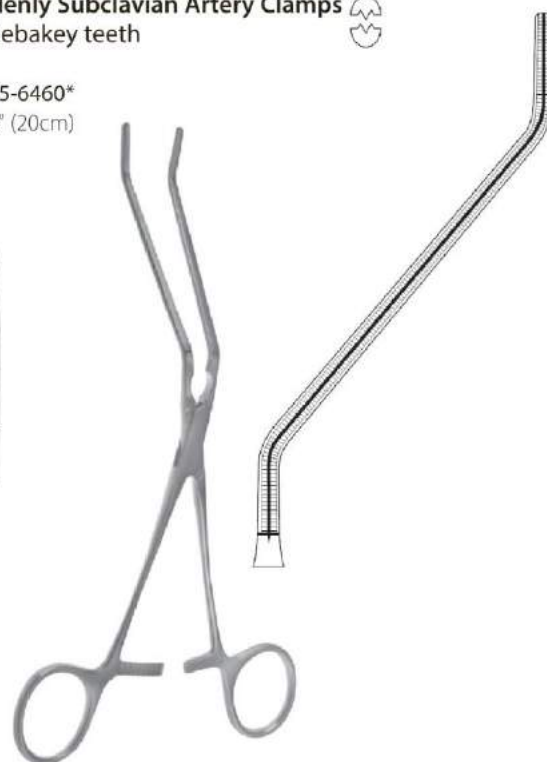

DeBakey Aorta Clamps 
multi-purpose

65-6465
angled 90°
8 3/4" (22.2cm)

65-6466*
angled 90°
8" (20cm)

65-6467
angled 90°
8 1/2" (21.5cm)

65-6468
angled 90°
11" (28cm)

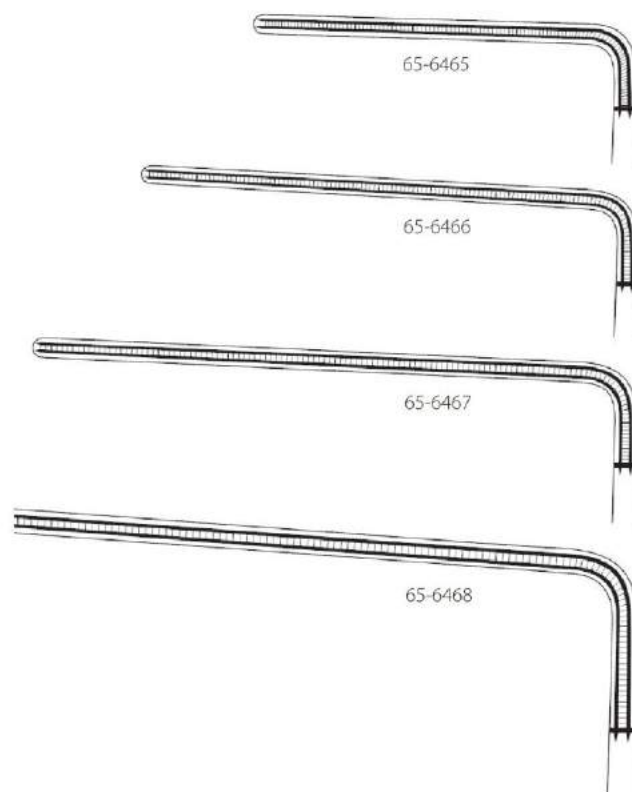

Favaloro-Semb Ligature Carriers

11" (28cm)
debaquey teeth



65-6472
half curved jaw

65-6473*
fully curved jaw



65-6472



65-6473

DeBakey-Semb Ligature Carrier

65-6475*
10 1/4" (26cm) overall length

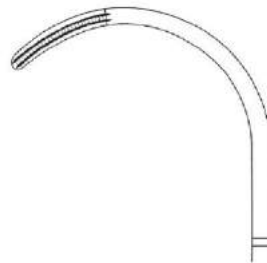

DeBakey Multi-Purpose Clamps 

65-6480
angled 60°
9 3/4" (23.5cm)

65-6481
angled 60°
8 1/4" (21cm)

65-6482*
angled 60°
9 1/2" (24cm)

65-6483
angled 60°
12" (30.5cm)

65-6484
set of 4



65-6480

65-6481

65-6482

65-6483

Dardik Multi-Purpose Clamps
debakey teeth 

65-6487
straight
5 3/4" (15cm)

65-6492
straight
6 1/2" (16.5cm)

65-6488
angled 15°
5 3/4" (15cm)

65-6493
angled 15°
6 1/2" (16.5cm)

65-6489
angled 30°
5 3/4" (15cm)

65-6494*
angled 30°
6 1/2" (16.5cm)

65-6490
angled 45°
5 3/4" (15cm)

65-6495
angled 45°
6 1/2" (16.5cm)

65-6491
angled 90°
5 3/4" (15cm)

65-6496
angled 90°
6 1/2" (16.5cm)

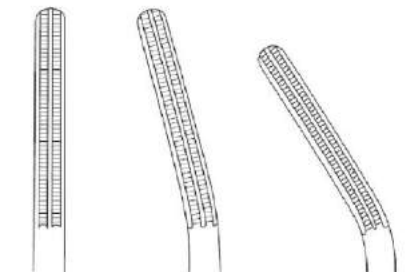
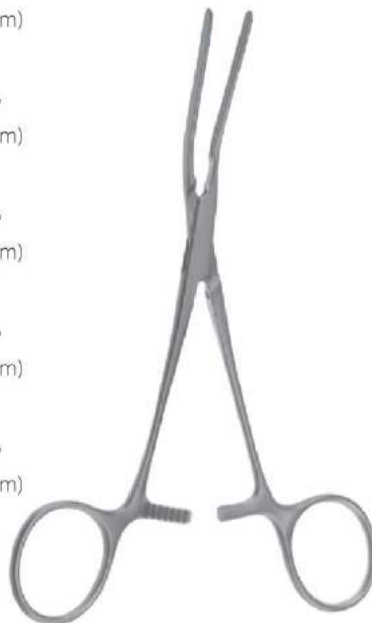

65-6487

65-6488

65-6489

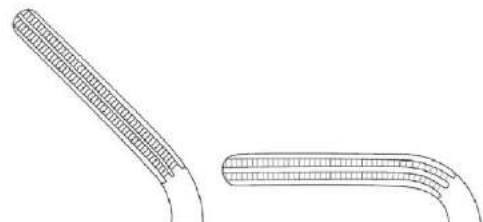

65-6490

65-6491

DeBakey Multi-Purpose Clamp



65-6499*
angled 25°
9" (23cm)

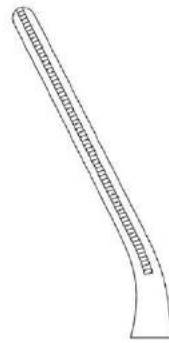

DeBakey Tangential Occlusion Clamps



65-6501
3.5cm jaws
1.1cm deep
7¾" (19.7cm)

65-6502
4.8cm jaws
1.6cm deep
9¾" (24.8cm)

65-6503*
5.5cm jaws
1.5cm deep
10" (25.4cm)

65-6504
6cm jaws
1.4cm deep
10" (25.4cm)

65-6505
7.5cm jaws
1.7cm deep
11" (28cm)

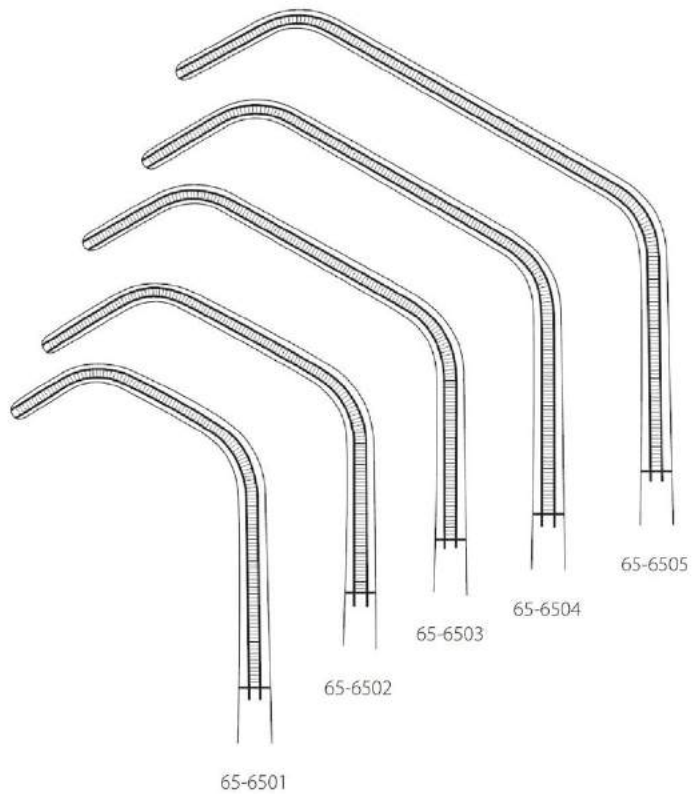

Satinsky Vena Cava Clamps
debakey teeth



65-6515
3.2cm jaws
8mm deep
10" (25.4cm)

65-6516
4cm jaws
9mm deep
10" (25.4cm)

65-6517
5cm jaws
1.3cm deep
10" (25.4cm)

65-6518
set of 3
one of each above

65-6515T
titanium
1.8cm jaws
9 1/8" (23.2cm)

65-6516T*
titanium
2.5cm jaws
9-1/8" (23.2cm)

65-6517T
titanium
3cm jaws
9 1/8" (23.2cm)

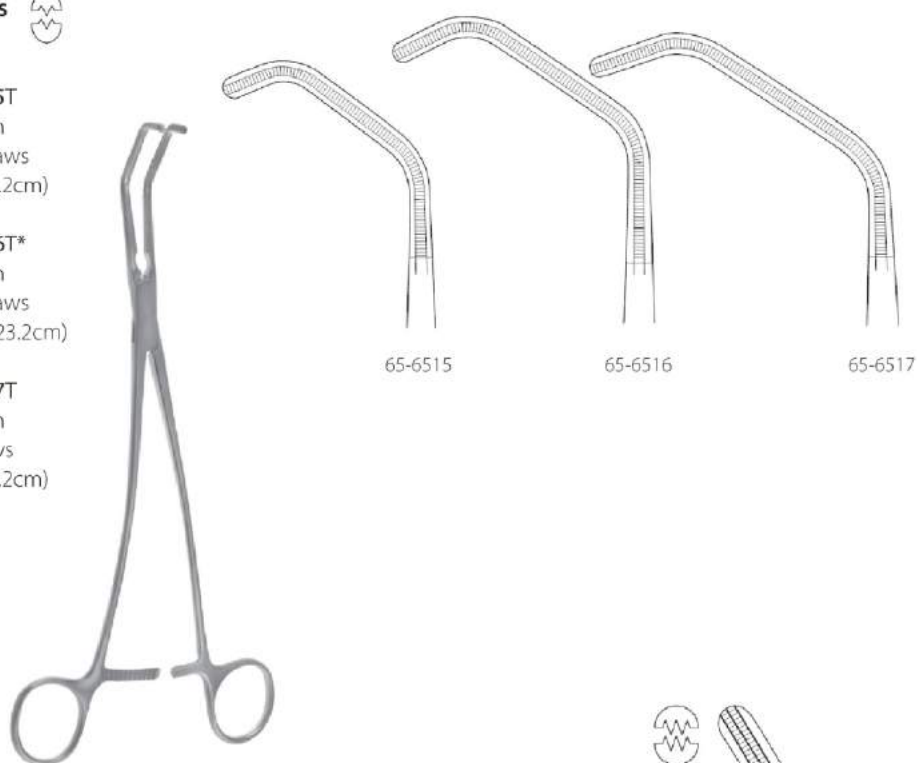

DeBaKey Aortic Aneurysm Clamps

65-6525
7.5cm jaw length
1x2 teeth
9 1/2" (24cm)

65-6526*
8.5cm jaw length
1x2 teeth
10 1/2" (27cm)

65-6527
10cm jaw length
2x3 teeth
12" (31cm)

65-6528
12cm jaw length
2x3 teeth
13" (33cm)

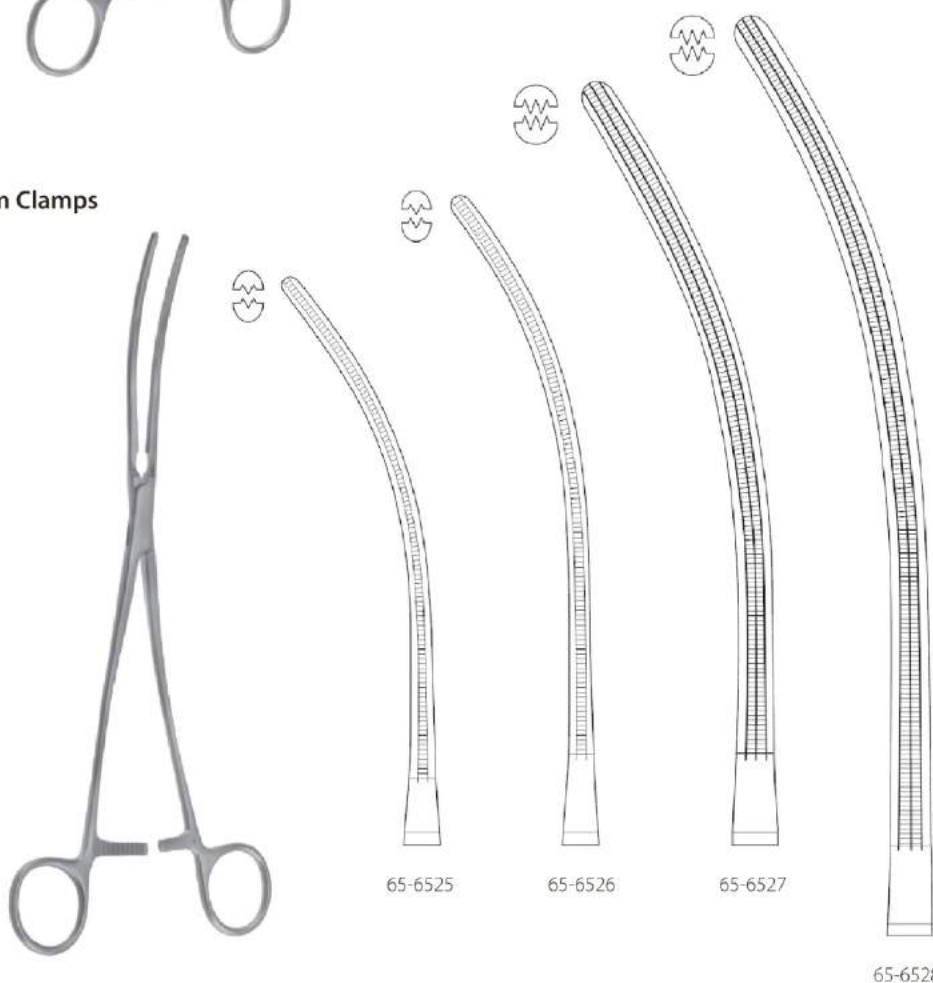

DeBakey Aortic Aneurysm Clamp



65-6530*
full curve
3³/₈" (8.6cm) jaw
9¹/₂" (24cm)



Howard Aortic Aneurysm Clamps
12¹/₄" (31cm)
debakey teeth

65-6535*
1x2 teeth
4¹/₄" (10.8cm) long

65-6536
2x3 teeth
4¹/₄" (10.8cm) long

65-6535A
strongly angled shanks
1x2 teeth
4¹/₄" (10.8cm) long

65-6536A
strongly angled shanks
2x3 teeth
4¹/₄" (10.8cm) long

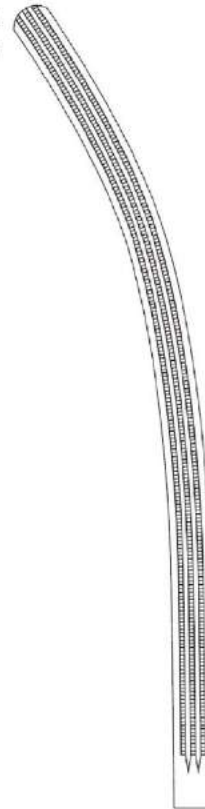
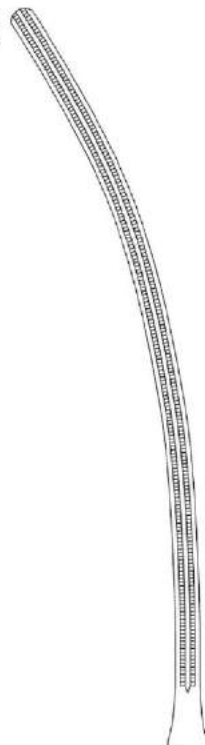

65-6535 / 65-6535A

65-6536 / 65-6536A

Cooley Aortic Aneurysm Clamp

65-6538*
curved jaw
10 1/4" (26cm)



Liddle Aortic Clamp

65-6559*
debakey jaw
1 3/8" (3.5cm) jaw
10 1/2" (27cm)

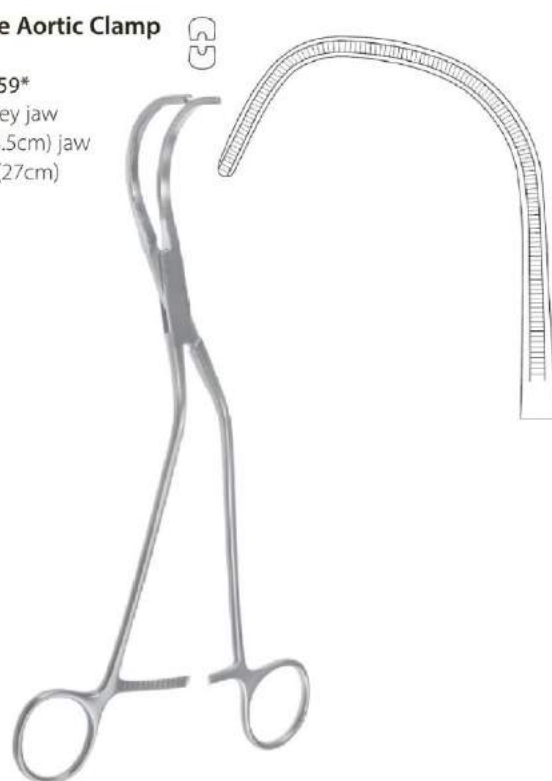

DeBakey Abdominal Aorta Clamps

65-6540
2x3 teeth
2 1/8" (5.5cm) long

65-6541*
1x2 teeth
2" (5cm) long

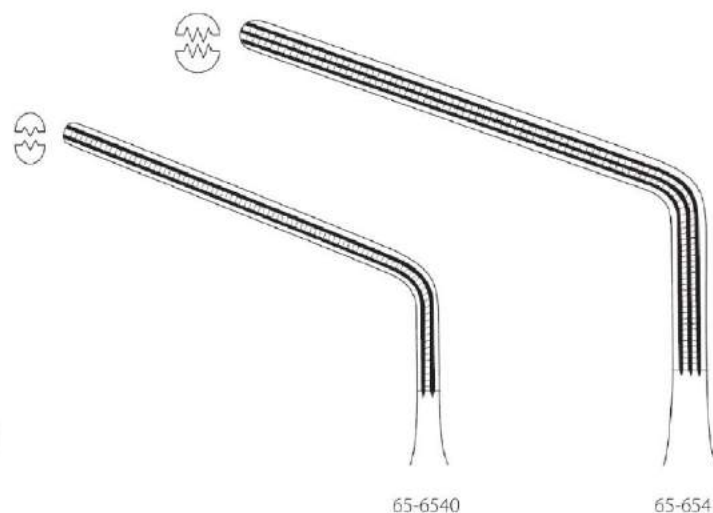

65-6540

65-6541

Cooley Aorta Clamps 

65-6542*
pediatric
8" (20cm)

65-6543
standard
10³/₄" (27.3cm)

65-6545
10" (25.4cm)

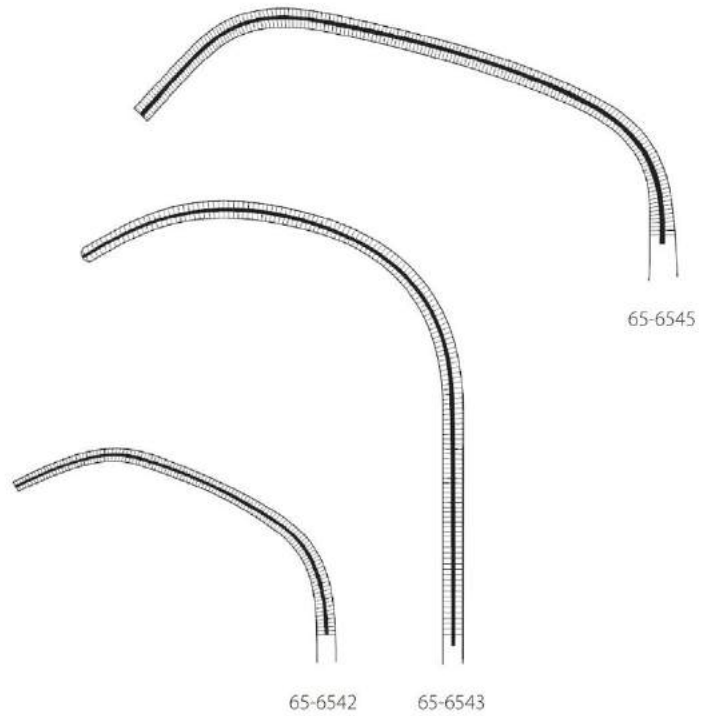

Fitzgerald Aortic Aneurysm Clamps 

65-6546
curved jaw
9³/₄" (24.8cm)

65-6547*
curved jaw
12" (30.5cm)

65-6548
curved jaw
12¹/₄" (31.1cm)

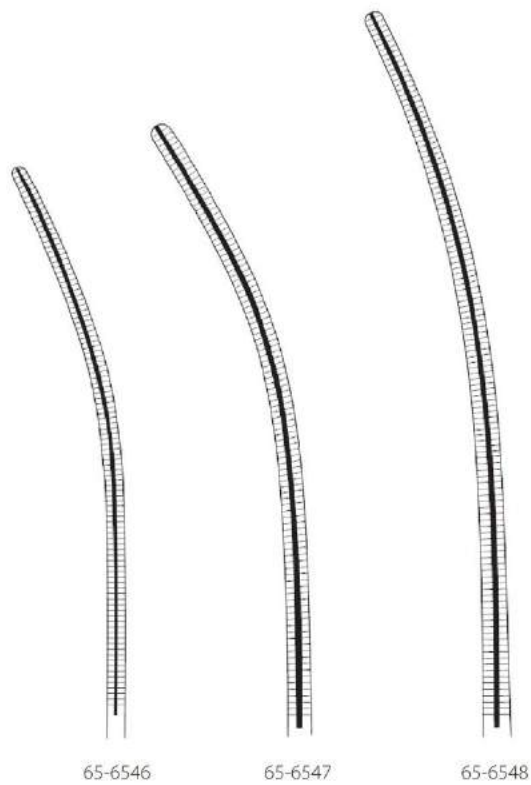

Kay Aortic Anastomosis Clamps
8" (20cm)
debakey teeth



65-6550*
1 3/4" (4.5cm) wide
1 1/4" (3.2cm) deep

65-6555
1 3/4" (4.5cm) wide
3/4" (1.9cm) deep

65-6550T
titanium
1 3/4" (4.5cm) wide
1 1/4" (3.2cm) deep

65-6555T
titanium
1 3/4" (4.5cm) wide
3/4" (1.9cm) deep



Ochsner Classic Aorta Clamps
debakey teeth



65-6557*
overall length:
10 7/8" (26.4cm)



Reul Aorta Clamps
cooley jaw



65-6558*
partial occlusion
2x2 vascular teeth
2 1/8" (5.5cm) jaw length
5/8" (1.5cm) jaw depth
10" (25.4cm)



Diethrich Aorta Clamp
debakey teeth



65-6560*
4.5cm wide
1.6cm deep
8 1/4" (21cm)



Parsonnet Aorta Clamps 
10 3/4" (26cm)
debakey teeth

65-6561*
1 1/8" (2.9cm) jaw

65-6562
1 1/4" (3.2cm) jaw

65-6563
1 1/2" (3.8cm) jaw

65-6564
1 3/4" (4.5cm) jaw

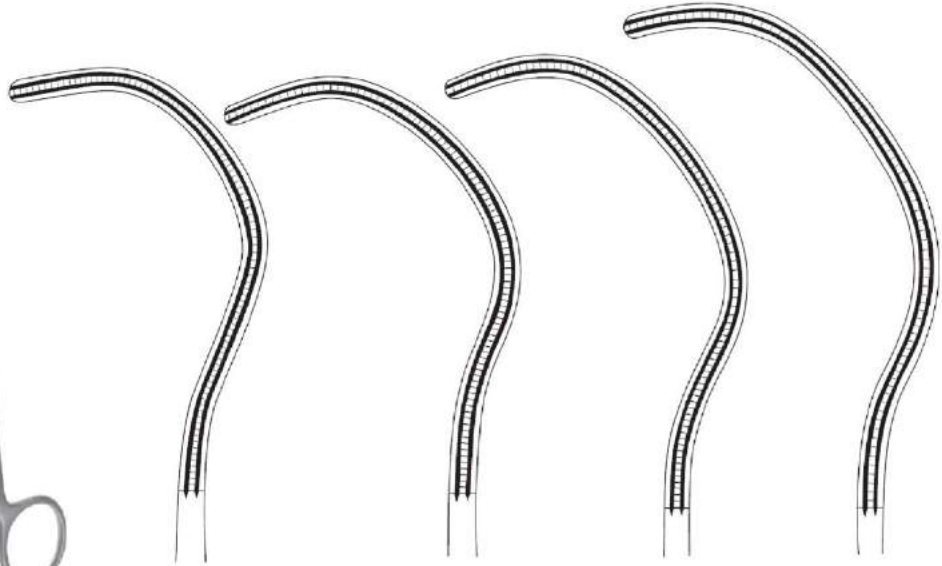

65-6561

65-6562

65-6563

65-6564

Harken Clamps 
10" (25.4cm)
debakey teeth

65-6565*
#1 curve

65-6566
#2 curve

65-6567
#3 curve

65-6568
#4 curve

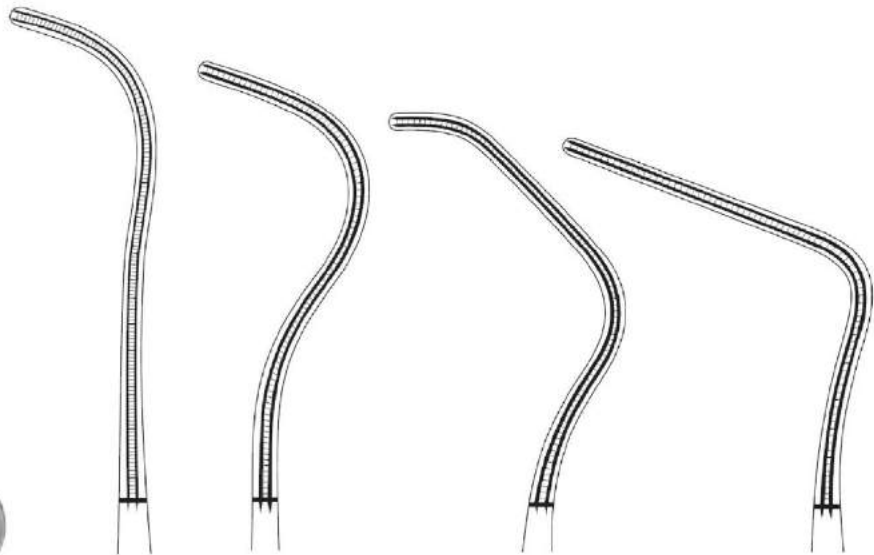

65-6565

65-6566

65-6567

65-6568

Wylie "J" Clamps 
debaquey teeth

65-6569

style 1

jaw 1 1/4" (3.2cm) wide

1" (2.5cm) deep

9 3/4" (24.8cm)

65-6570*

jaw 1 1/4" (3.2cm) wide

1" (2.5cm) deep

8 1/2" (21.5cm)

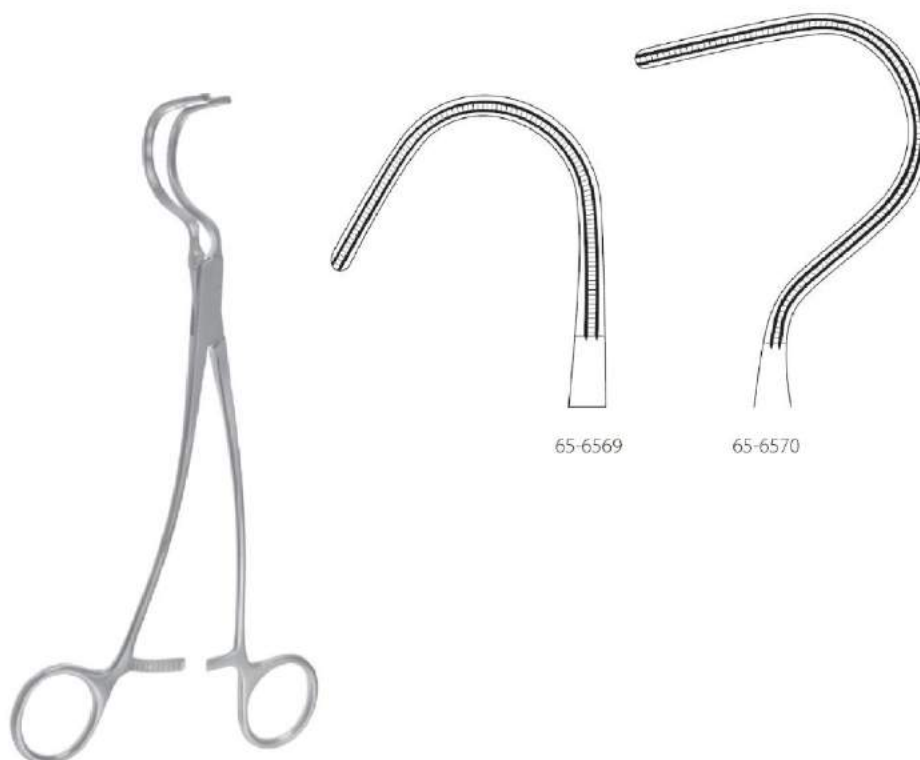

65-6569

65-6570

Wylie Hypogastric Clamps 
light curved jaw
debaquey teeth

65-6572*

9 1/2" (24cm)

65-6574

70mm jaw

10 1/2" (26.5cm)

65-6576

65mm jaw

10 5/8" (27cm)



Wylie Abdominal Clamp 
strong curved jaw
debakey teeth

65-6573*

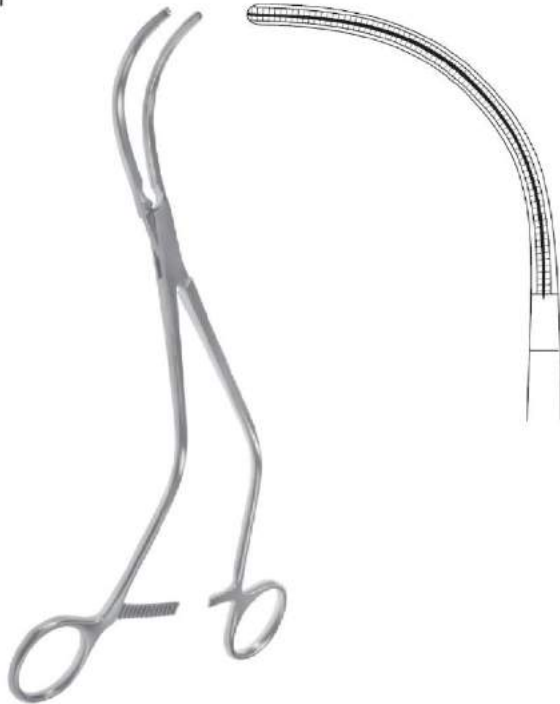

Glover Atrial Appendage Clamp 
debakey teeth

65-6575*
9" (23cm)



Glover Clamps 
debakey teeth

65-6580*
standard
curved
8 1/4" (21cm)

65-6581
long
curved
9 1/2" (24cm)

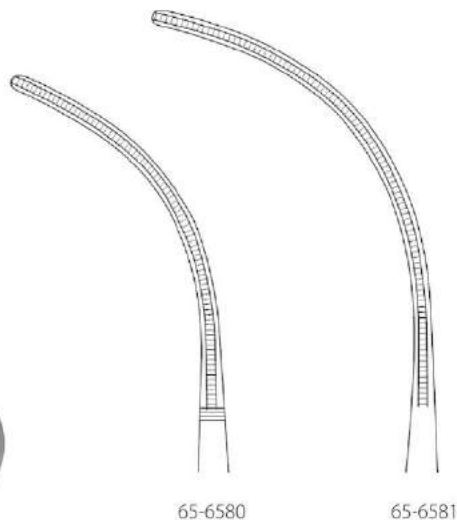

65-6580

65-6581

240

Glover Clamps
debakey teeth 

65-6582
curved right angle
7 1/4" (18.5cm)

65-6583*
long
curved right angle
8" (20cm)

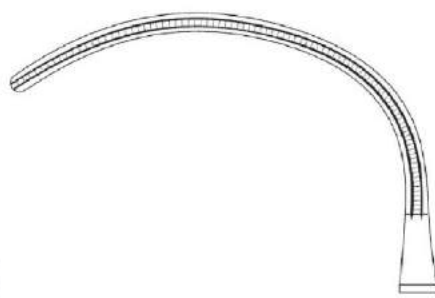

65-6582

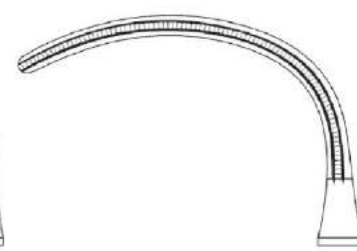

65-6583

Glover Clamps
debakey teeth 

65-6584
standard
spoon jaw
8 1/2" (21.5cm)

65-6585*
long
spoon jaw
9 1/2" (24cm)

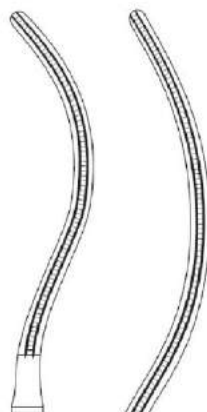

65-6584



65-6585

Glover Spoon Jaw Anastomosis Clamps
cooley jaw 

65-6586*
8 1/2" (21.5cm)



Glover Clamps
cooley jaw



65-6587*
curved
2" (5cm) jaw
8½" (21.5cm)

65-6588
curved
2¾" (7cm) jaw
9½" (24cm)

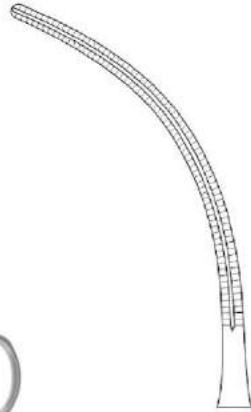

65-6587

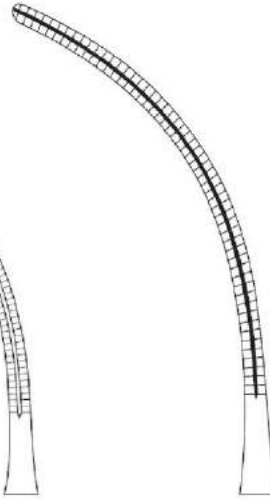

65-6588

Renal Artery Clamps
cooley jaw



65-6590
2½" (6.4cm) jaw
7" (18cm)

65-6591
3" (7.5cm) jaw
9" (23cm)

65-6592*
10¾" (27.3cm)



65-6590



65-6591



65-6592

Gregory Profunda Clamps 
debakey teeth

65-6599
extra small
5" (12.5cm)

65-6600
small
6 1/2" (16.5 cm)

65-6601
medium
7" (18cm)

65-6602*
large
7 1/2" (19cm)

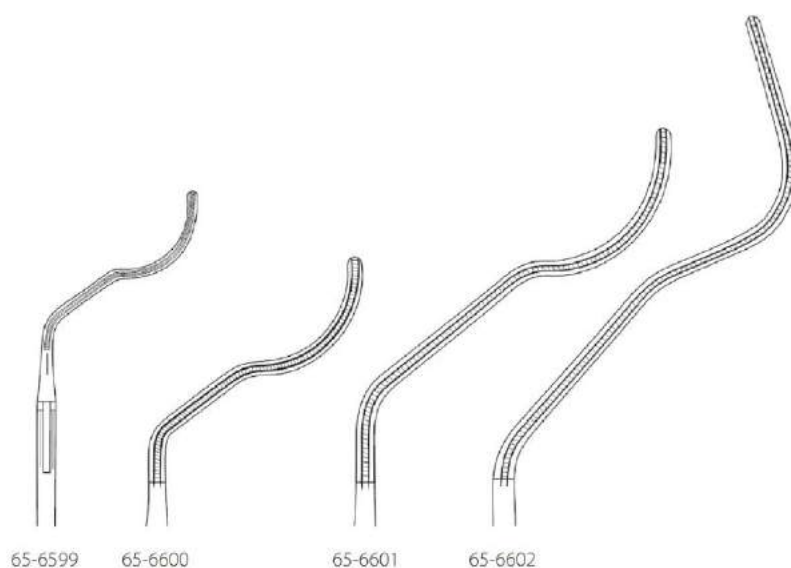
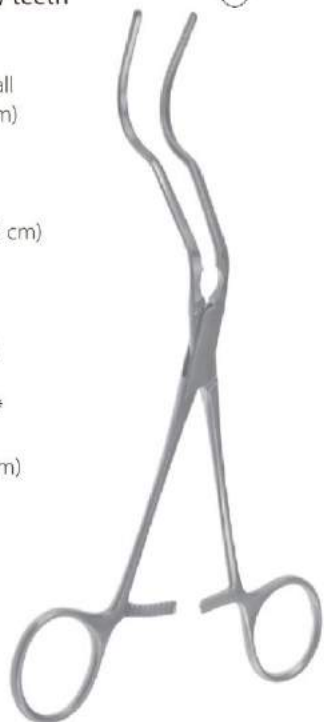

Wirthlin Spleno-Renal Shunt Clamps 
debakey teeth

65-6610*
6 1/2" (16.5cm)

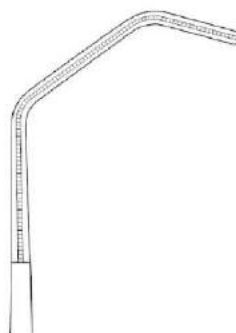



Stoney Spleno-Renal Shunt Clamps 
debaquey teeth

65-6615*
small
8 1/4" (21cm)

65-6616
medium
9" (23cm)

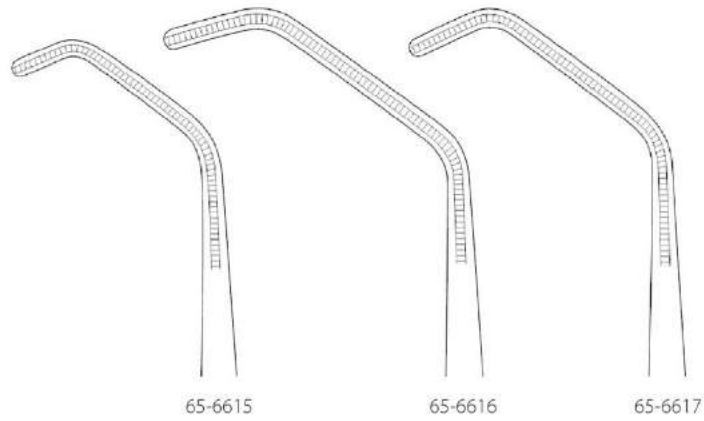
65-6617
large
8 1/2" (21.5cm)



Dale Improved "Fem-Pop" Anastomosis Clamps 
debaquey teeth

65-6625*
7 1/4" (18.5cm)

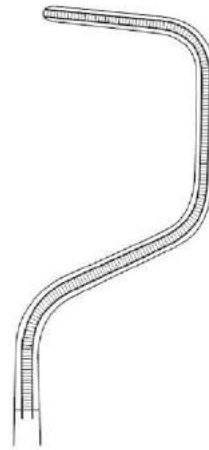

Dale "Fem-Pop" Anastomosis Clamps
debakey teeth



65-6630*
small
1/2" (.3cm) jaw length
6 3/4" (17.1cm)

65-6631
medium
3/4" (1.9cm) jaw length
6 3/4" (17.1cm)

65-6632
large
1" (2.5cm) jaw length
7 1/4" (18.5cm)

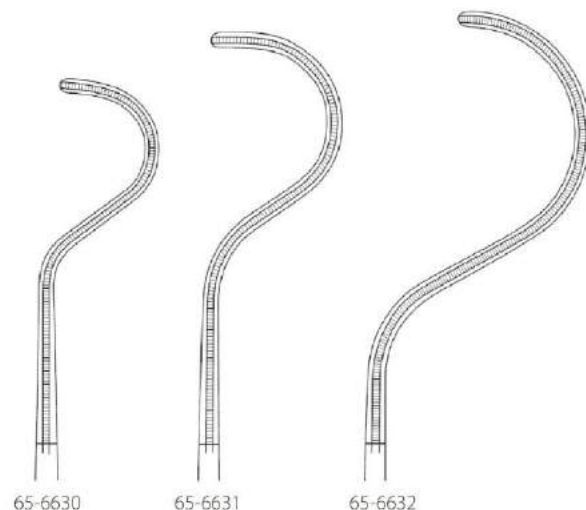

Wylie External Carotid Clamps
debakey teeth



65-6635*
8 1/4" (21cm)

65-6637
8" (20cm)



Demos Tibial Artery Clamp
debakey teeth



65-6640*
8 1/4" (21cm)



Lambert-Kay Aortic Anastomosis Clamp
debakey teeth



65-6645*
8 3/4" (21cm)



Mitchell Aortotomy Clamps
debakey teeth



65-6650*
8" (20cm)

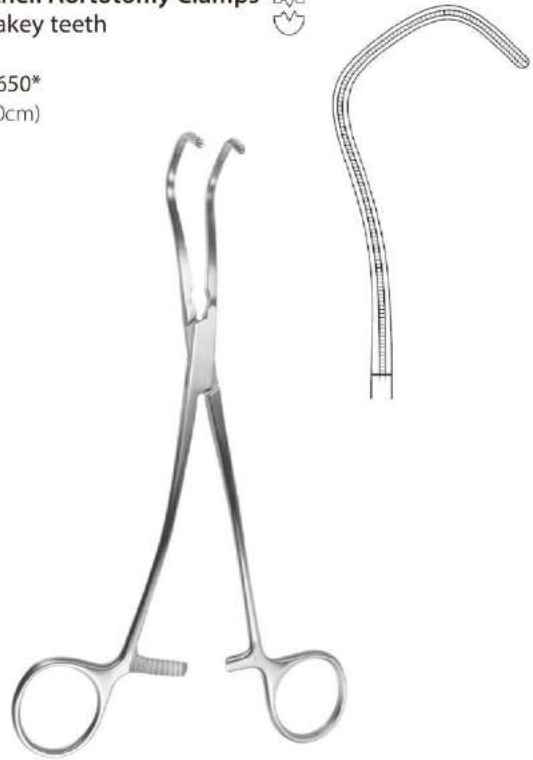

Zanger Abdominal Aorta Clamps
debakey teeth

65-6660
curved shanks
9" (23cm)

65-6661*
curved shanks
9 1/2" (24cm)

65-6662
curved shanks
12 1/4" (31.1cm)

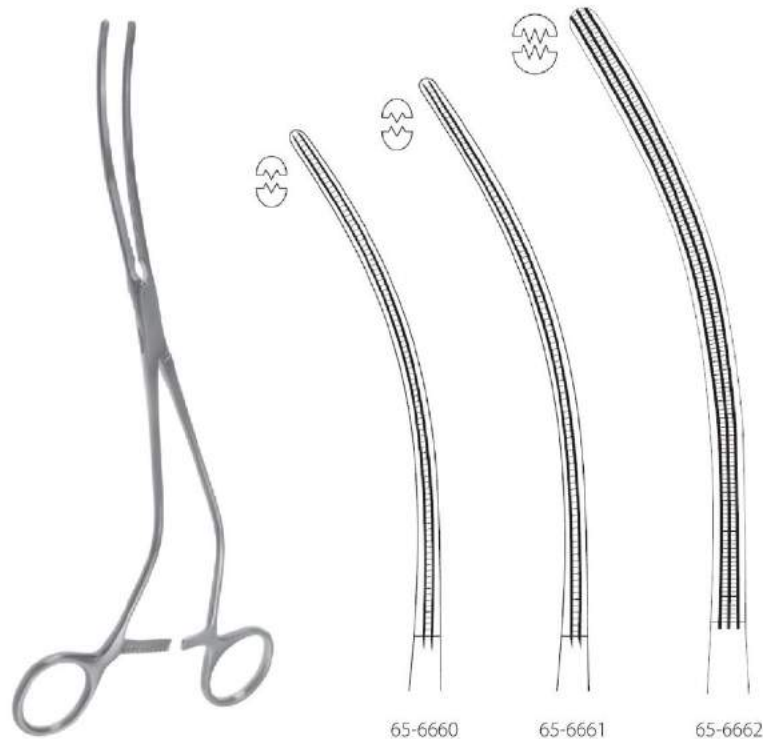

65-6660

65-6661

65-6662

Zanger Abdominal Aorta Clamps
 acutely angled shanks
 debakey teeth

65-6661A
 9 1/2" (24cm)

65-6662A*
 12 1/4" (31.1cm)

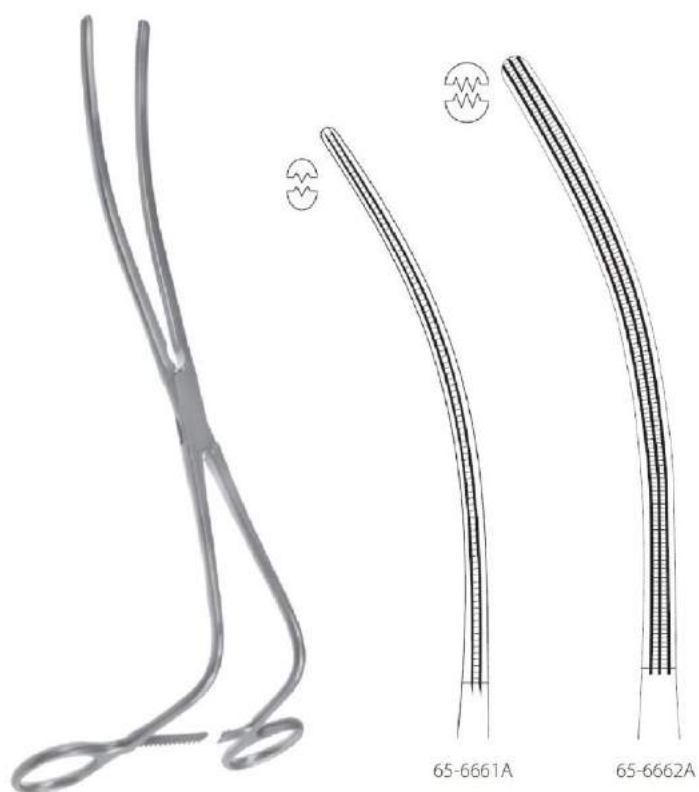

Weber Aortic Clamps
 10 1/4" (26cm)
 debakey teeth



65-6665*
 right

65-6666
 left



Bahnsen Aortic Clamps 
debakey teeth

65-6668*
9" (23cm)



DeBakey-Bahnsen Clamps 

65-6670*
acute curve
9" (23cm)

65-6671
medium curve
9 1/2" (24cm)

65-6672
slight curve
10" (25.4cm)

65-6673
set of 3
one of each

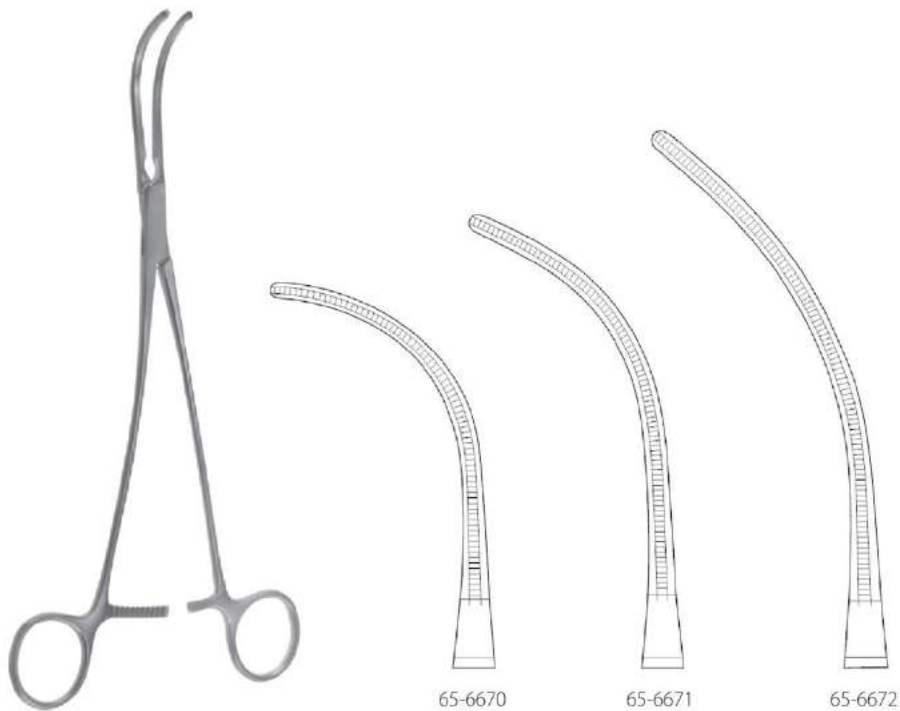

Crafoord Coarctation Vascular Clamp
debakey teeth

65-6675*
9 1/4" (23.5cm)



Crawford Thoraco-Abdominal Aneurysm Clamps
debakey teeth

65-6678*
curved jaw
angled handle
13" (33cm) overall length

65-6679
"S" curve
angled tips
14" (35.6cm) overall length

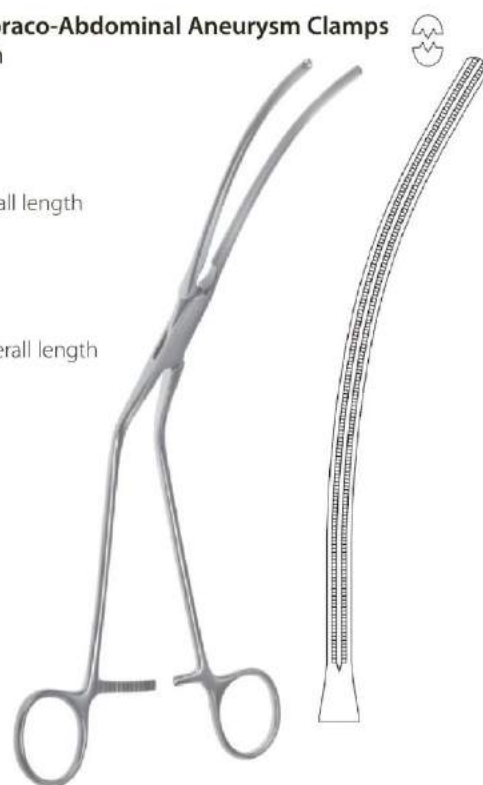

Morris Ascending Aorta Clamps
debakey teeth

65-6680
original ascending
8 1/4" (21cm)

65-6681*
long ascending
10" (25.4cm)

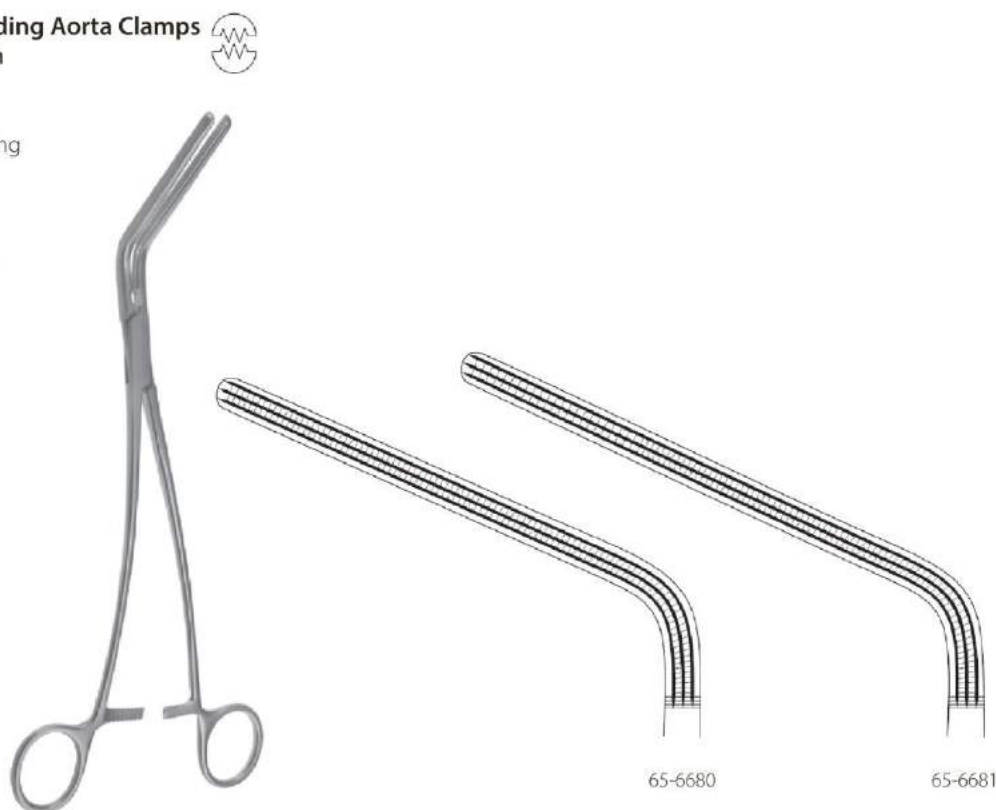

65-6680

65-6681

Grant Abdominal Aorta Clamps
debakey teeth

65-6685*
2½" jaw, curved
10½" (26.7cm)

65-6686
short jaw
1¾" (4.5cm)
9½" (24cm)

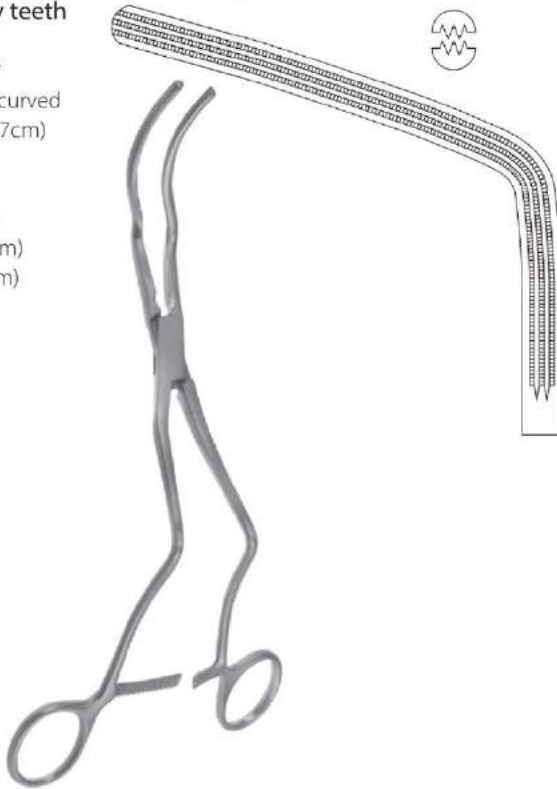

Cherry Supraceliac Clamps
debakey teeth

65-6687*
curved jaw
handle angled 60°
12" (30.5cm)

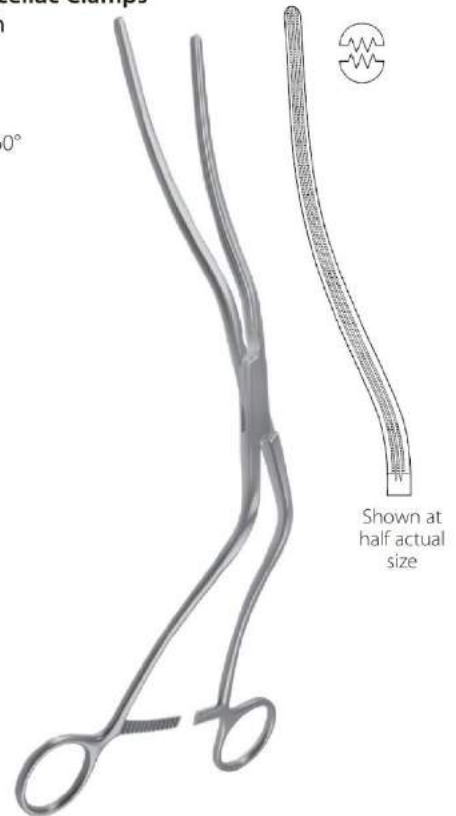

Lambert Abdominal Aorta Clamp
debakey teeth

65-6690*
8¾" (22.2cm)

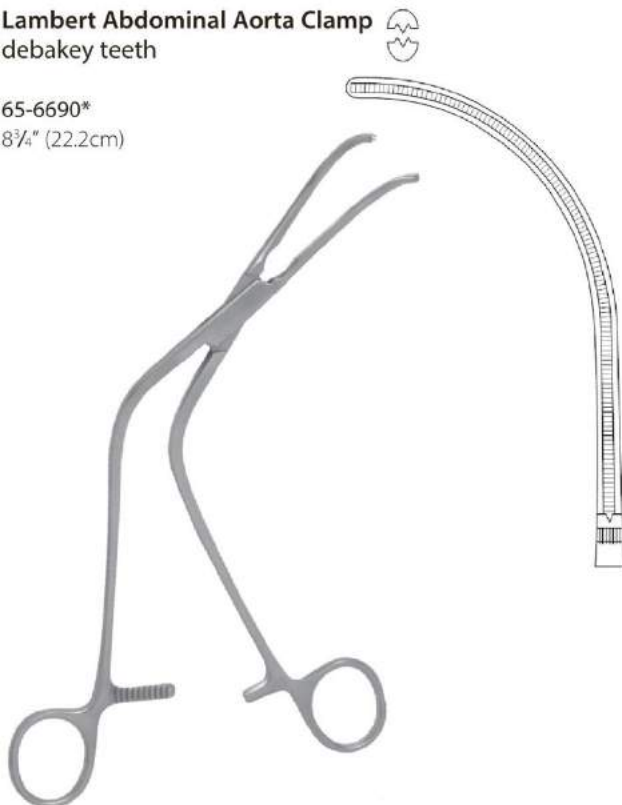

Schumaker Aortic Clamps
debakey teeth

65-6692*
angled 60°
8¾" (21.3cm)

65-6693
angled 60°
8¾" (22.2cm)

65-6694
angled 60°
11½" (29.2cm)



Strelinger Right Angled Clamps
debakey teeth

65-6697*
large
atraumatic
2 3/4" (7cm) jaw
9 1/2" (24cm)



Strong Aorta Clamps
8" (20cm)
debakey teeth

65-6701*
straight shanks
65-6702
angled shanks



Lemole Strong Aorta Clamps
8" (20cm)
debakey teeth

65-6703*
straight shanks
65-6704
angled shanks

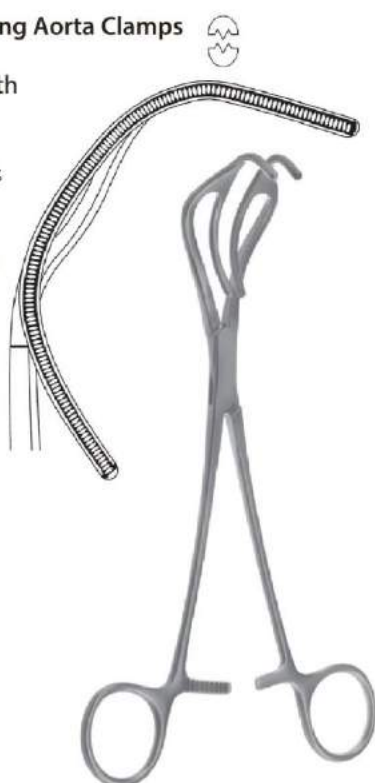

Aortic Clamps
cooley jaw

65-6706*
slightly curved
shank and jaw
2 1/2" (6.4cm) jaw
7 1/2" (19cm) overall length

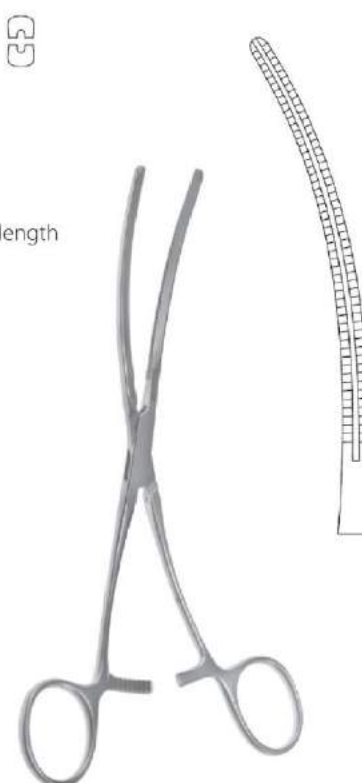

Cooley Patent Ductus Clamps
8" (20cm)



65-6710*
straight shanks

65-6711
angled shanks



Cooley Coarctation Clamps



65-6715*
straight shanks
8¾" (22.2cm)

65-6718
straight shanks
straight jaw
9¾" (24.8cm)

65-6716
angled shanks
8¾" (22cm)

65-6719
angled shanks
straight jaw
9¾" (25cm)



65-6715
65-6716

65-6718
65-6719

Vena Cava Clamp
cooley jaw



65-6721*
8" (20cm)

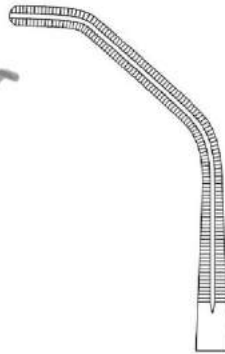

Cooley Partial Occlusion Clamps 

65-6725
 $\frac{7}{8}$ " (2.2cm) jaws
 $\frac{3}{32}$ " (7mm) deep
 $7\frac{3}{4}$ " (19.5cm)

65-6726*
 $1\frac{3}{8}$ " (3.5cm) jaws
 $\frac{7}{16}$ " (8mm) deep
 $8\frac{1}{2}$ " (21.5cm)

65-6727
 2 " (5.2cm) jaws
 $\frac{1}{2}$ " (12mm) deep
 $8\frac{1}{2}$ " (21.5cm)

65-6728
 $2\frac{1}{4}$ " (6cm) jaws
 $\frac{1}{2}$ " (12mm) deep
 $8\frac{1}{2}$ " (21.5cm)

65-6729
 $2\frac{7}{8}$ " (7.3cm) jaws
 $\frac{1}{2}$ " (12mm) deep
 $8\frac{3}{4}$ " (22cm)

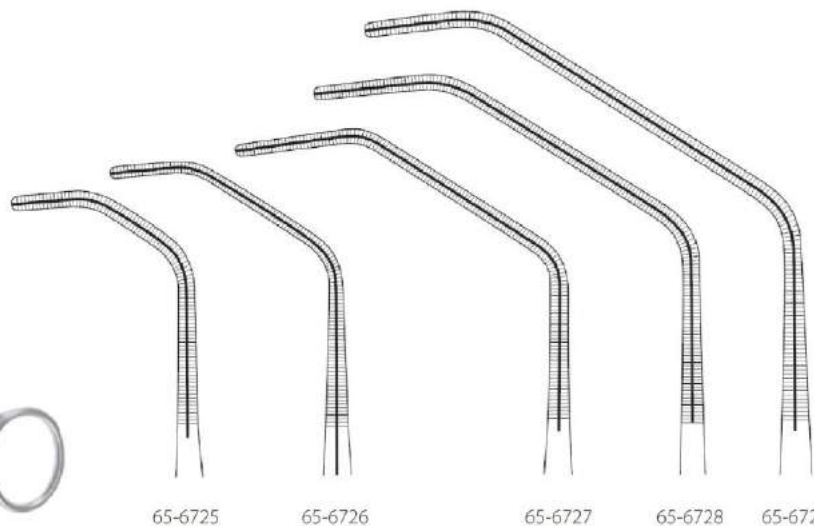

Cooley Multi-Purpose Clamps 

65-6731
 angled 60°
 $9\frac{1}{2}$ " (24cm)

65-6732*
 angled 60°
 9 " (23cm)

65-6733
 angled 60°
 $2\frac{3}{4}$ " (7cm) jaw
 $9\frac{1}{2}$ " (24cm)

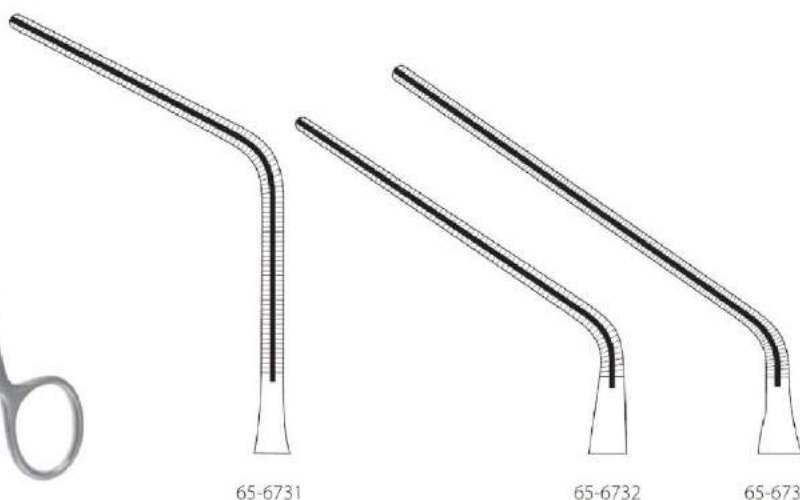

Cooley Occlusion Clamps



65-6735*
1⁷/₆₄" (3.6cm) long
7¹/₄" (18.5cm)

65-6736
1⁷/₆₄" (3.6cm) long
8¹/₄" (21cm)

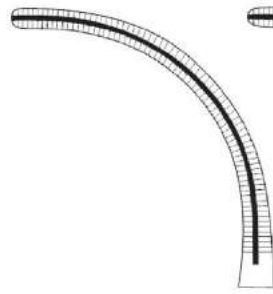

65-6736

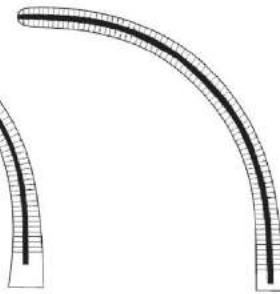

65-6735

Cooley Tangential Occlusion Clamps



7³/₄" (19.7cm)

65-6740
1/4" (6mm) deep
1³/₁₆" (2cm) wide

65-6741*
1/2" (7mm) deep
1" (2.5cm) wide

65-6742
3/8" (10mm) deep
1¹/₂" (3.4cm) wide



65-6740

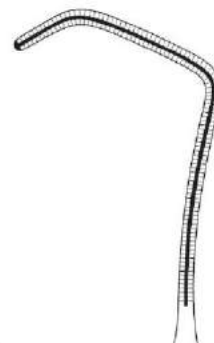

65-6741



65-6742

Lee Bronchus Clamps debakey teeth



65-6750*
right angle
straight shanks
8½" (21.5cm)

65-6751
double angle
curved shanks
9¼" (23.5cm)

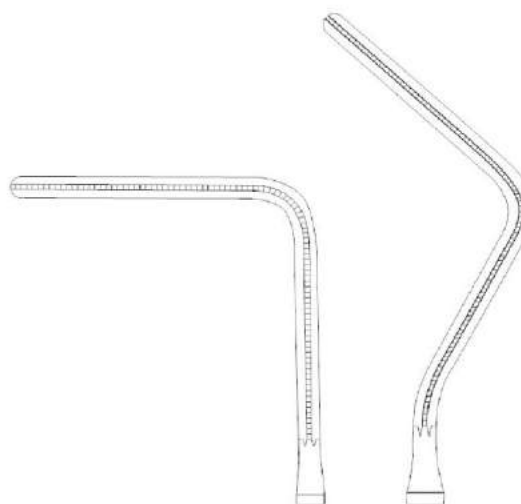

65-6750

65-6751

Fogarty-Type Safe Jaw Clamps

65-6760
straight
6½" (16.5cm)

65-6762*
angled jaw
5" (12.5cm)

65-6764
straight
11½" (29.2cm)

65-6766
angled jaw
8¾" (22.2cm)

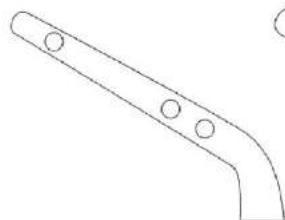

65-6762

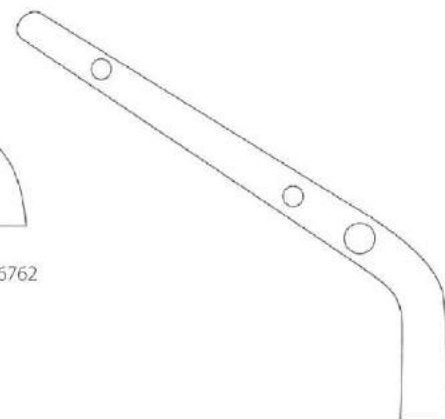

65-6766

Fogarty-Type Safe Jaw Clamps

65-6768
angled
8½" (21.5cm)

65-6770*
angled
9¼" (23.5cm)



Fogarty-Type Safe Jaw Clamps

65-6772*
straight
overall length:
12¼" (31.1cm)



DeBakey-Bainbridge Vascular Clamps

65-6787
straight
1⅝" (4cm) jaw
6" (15cm)

65-6788
curved
1⅝" (4cm) jaw
6¾" (17.1cm)

65-6789
straight
2⅜" (6cm) jaw
7⅞" (20cm)

65-6790*
curved
2⅜" (6cm) jaw
7" (18cm)

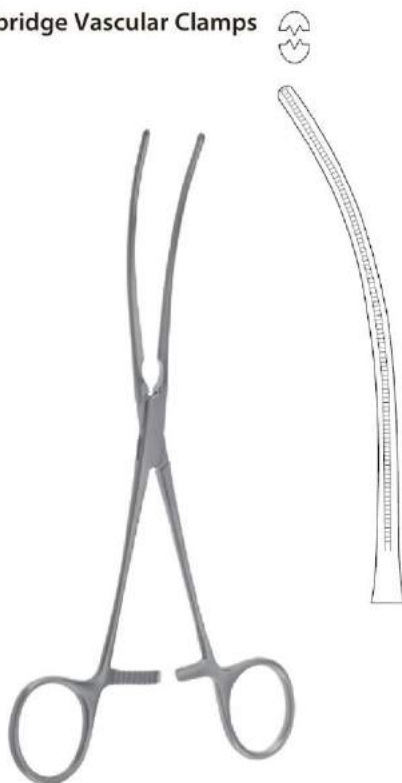

Mini Coarctation Clamps

6½" (17cm)
debakey teeth

65-6795
1¾" (4.5cm) jaw

65-6794*
straight jaws
angular shanks
1¾" (4.5cm) jaw

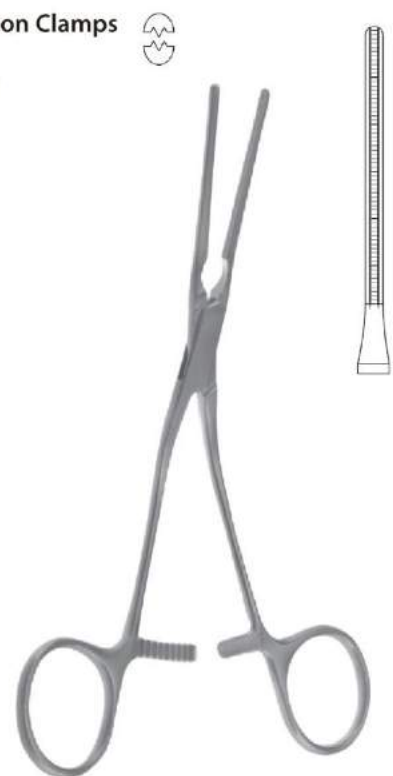

Javid-Style Carotid Bypass Shunt Clamps

65-7055*
large
1/4" (6mm)
7 1/8" (18.1cm)

65-7056
small
1/32" (4mm)
6 3/4" (17.1cm)



65-7055



65-7056

Cooley Caval Occlusion Forceps
8 1/4" (21cm)

65-7080
24Fr

65-7081*
26Fr

65-7082
28Fr

65-7083
30Fr

65-7084
32Fr

65-7085
34Fr

65-7086
36Fr

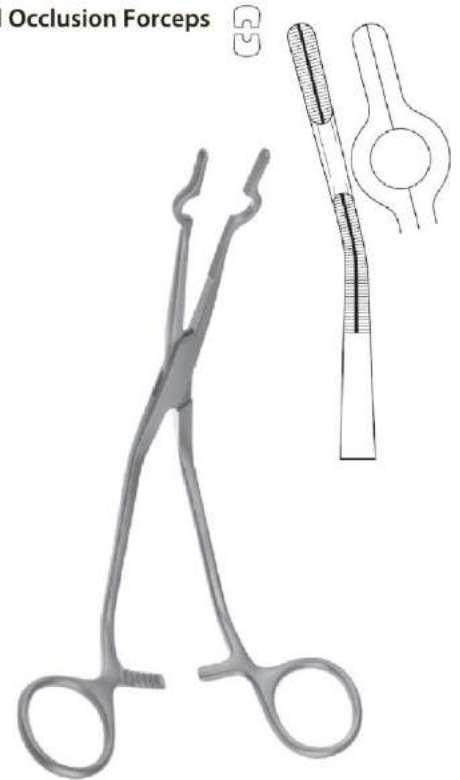

Fogarty Spring Clip Applicators

65-6840*
7 1/4" (18.5cm) overall length



Semb Dissecting Ligature Forceps

60-1428
slight curve
9" (23cm)

60-1430*
strong curve
9½" (24cm)



60-1428

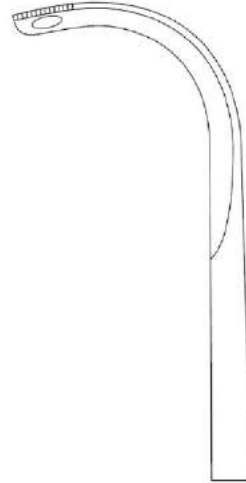

60-1430

Sarot Bronchus Clamps
9" (23cm)

60-1435*
left
1½" (3.8cm) wide jaw

60-1436
right
1½" (3.8cm) wide jaw

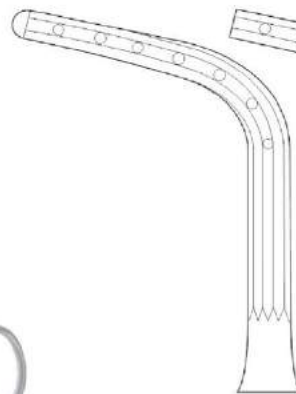

60-1435

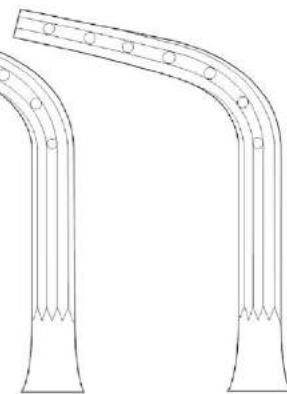

60-1436

Precision Surgical Ltd supplies the following brands:-



Other brochures available from Precision Surgical upon request.

